

2015 OKLAHOMA MINIMUM SCHOOL BUS SPECIFICATIONS

These specifications will be in effect beginning April 1, 2018.

AIR CLEANER

- A. A dry element air cleaner shall be provided.
- B. All diesel engine air filters shall include a latch-type restriction indicator that retains the maximum restriction developed during operation of the engine. The indicator should include a reset control so the indicator can be returned to zero when desired.

AISLE

All emergency exit doors shall be accessible by a 12-inch minimum aisle. The aisle shall be unobstructed at all times by any type of barrier, seat, wheelchair or tie-down, unless a flip seat is installed and occupied. The track of a track seating system is exempt from this requirement. A flip seat in the unoccupied (up) position shall not obstruct the 12-inch minimum aisle to any side emergency exit door.

AXLES

The front and rear axle and suspension systems shall have a gross axle weight rating (GAWR) at ground commensurate with the respective front and rear weight loads of the bus loaded to the rated passenger capacity.

BACK-UP WARNING ALARM

An automatic audible alarm shall be installed behind the rear axle and shall comply with the published Backup Alarm Standards (SAE J994b), providing a minimum of 112 dBA, or shall have a variable volume feature that allows the alarm to vary from 87 dBA to 112 dBA sound level, staying at least 5 dBA above the ambient noise level.

BRAKES: GENERAL

- A. The chassis brake system shall conform to the provisions of FMVSS Nos. 105, *Hydraulic and Electric Brake Systems*, 106, *Brake Hoses*, and 121, *Air Brake Systems*, as applicable. All buses shall have either a parking pawl in the transmission or a park brake interlock that requires the service brake to be applied to allow release of the parking brake.
- B. The anti-lock brake system (ABS), provided in accordance with FMVSS No. 105, *Hydraulic and Electric Brake Systems* or No. 121, *Air Brake Systems*, shall provide wheel speed sensors for each front wheel and for each wheel on at least one rear axle. The system shall provide anti-lock braking performance for each wheel equipped with sensors (Four Channel System).
- C. All brake systems shall be designed to permit visual inspection of brake lining wear without removal of any chassis component(s).
- D. The brake lines, booster-assist lines, and control cables shall be protected from

excessive heat, vibration and corrosion and installed in a manner that prevents chafing.

- E. The parking brake system for either air or hydraulic service brake systems may be of a power-assisted design. The power parking brake actuator should be a device located on the instrument panel within reach of seated a 5th percentile female driver. As an option, the parking brake may be set by placing the automatic transmission shift control mechanism in the “park” position.
- F. The power-operated parking brake system may be interlocked to the engine key switch. Once the parking brake has been set and the ignition switch turned to the “off” position, the parking brake cannot be released until the key switch is turned back to the “on” position.

BRAKES: HYDRAULIC

Buses using hydraulic-assist brakes shall meet requirements of FMVSS 105.

BRAKES: AIR

- A. The air pressure supply system shall include a desiccant-type air dryer installed according to the manufacturer’s recommendations. The air pressure storage tank system shall incorporate an automatic drain valve.
- B. The chassis manufacturer shall provide an accessory outlet for air-operated systems installed by the body manufacturer. This outlet shall include a pressure protection valve to prevent loss of air pressure in the service brake reservoir.
- C. For air brake systems, an air pressure gauge shall be provided in the instrument panel capable of complying with Commercial Driver’s License (CDL) pre-trip inspection requirements.
- D. Air brake systems shall include a system for anti-compounding of the service brakes and parking brakes.
- E. Air brakes shall have both a visible and audible warning device whenever the air pressure falls below the level where warnings are required under FMVSS No. 121, *Air Brake Systems*.

BUMPER: FRONT

- A. School buses shall be equipped with a front bumper.
- B. The front bumper on buses of Type A-2 (with GVWR greater than 14,500 pounds), Type B, Type C, and Type D shall be equivalent in strength and durability to pressed steel channel at least 3/16 inches thick and not less than 8 inches wide (high). It shall extend beyond the forward-most part of the body, grille, hood and fenders and shall extend to the outer edges of the fenders at the bumper’s top line. Type A buses having a GVWR of 14,500 pounds or less may be equipped with an OEM-supplied front bumper. The front bumper shall be of sufficient strength to permit being pushed by another vehicle on a smooth surface with a 5 degree, (8.7 percent) grade, without permanent distortion. The contact point on the front bumper is intended to be between the frame rails with as wide a contact area as possible. If the front bumper is used for lifting, the contact points shall be under the bumper attachments to the frame rail brackets unless the

manufacturer specifies different lifting points in the owner's manual. Contact and lifting pressures should be applied simultaneously at both lifting points.

- C. The front bumper, except breakaway bumper ends, shall be of sufficient strength to permit pushing a vehicle of equal gross vehicle weight, per Section B, without permanent distortion to the bumper, chassis or body.
- D. The bumper shall be designed or reinforced so that it will not deform when the bus is lifted by a chain that is passed under the bumper (or through the bumper if holes are provided for this purpose) and attached to both tow hooks/eyes. For the purpose of meeting this specification, the bus shall be empty and positioned on a level, hard surface and both tow hooks/eyes shall share the load equally.

BUMPER: REAR

- A. The bumper on Type A-1 buses shall be a minimum of 8 inches wide (high). Bumpers on Types A-2, B, C and D buses shall be a minimum of 9½ inches wide (high). The bumper shall be of sufficient strength to permit being pushed by another vehicle of similar size and being lifted by the bumper without permanent distortion.
- B. The bumper shall wrap around the back corners of the bus. It shall extend forward at least 12 inches, measured from the rear-most point of the body at the floor line, and shall be mounted flush with the sides of the body or protected with an end panel.
- C. The bumper shall be attached to the chassis frame in such a manner that it may be removed. It shall be braced to resist deformation of the bumper resulting from impact from the rear or the side. It shall be designed to discourage hitching of rides by an individual.
- D. The bumper shall extend at least one inch beyond the rear-most part of the body surface, measured at the floor line.
- E. The bottom of the rear bumper shall not be more than 30 inches above ground level.

CERTIFICATION

Upon request of the state agency having student transportation jurisdiction, the chassis and body manufacturer(s) shall certify that its(their) product(s) meets the state's minimum standards on items which are not covered by FMVSS certification requirements of 49 CFR, Part 567: *Certification*.

COLOR

- A. The school bus body shall be painted National School Bus Yellow (NSBY). (See APPENDIX A in *National School Transportation Specifications and Procedures 2015*)
- B. The body exterior trim, rub rails and background of red and amber flashers, shall be black or NSBY. Rub rails may be painted in such a way that only the entire raised center section of the rail is black.
- C. Except for the vertical portion of the front and rear roof caps, the roof of the bus shall be painted white. (See illustration in APPENDIX, Placement of Retroreflective Markings.)

- D. The chassis and front bumper shall be black. Body, cowl, hood and fenders shall be in National School Bus Yellow (NSBY). The flat top surface of the hood may be non-reflective black or NSBY. (See APPENDIX)
- E. Wheels may be silver, gray, white, yellow or black.
- F. Multi-Function School Activity Buses (MFSABs) shall be exempt from these requirements.

CONSTRUCTION

- A. Side Intrusion Test: The bus body shall be constructed to withstand an intrusion force equal to the curb weight of the vehicle or 20,000 pounds, whichever is less. Each vehicle shall be capable of meeting this requirement when tested in accordance with the procedures set forth below. The complete body structure, or a representative seven-body section mock up with seats installed, shall be load tested at a location 24 ± 2 inches above the floor line, with a maximum 10 inch diameter cylinder, 48 inches long, mounted in a horizontal plane. The cylinder shall be placed as close as practical to the mid-point of the tested structure, spanning two internal vertical structural members. The cylinder shall be statically loaded to the required force of curb weight or 20,000 pounds, whichever is less, in a horizontal plane with the load applied from the exterior toward the interior of the test structure. When the minimum load has been applied, the penetration of the loading cylinder into the passenger compartment shall not exceed 10 inches from its original point of contact. There can be no separation of lapped panels or construction joints. Punctures, tears or breaks in the external panels are acceptable but are not permitted on any adjacent interior panel. Body companies shall certify compliance with this intrusion requirement, and include test results, as requested.
- B. Construction shall be reasonably dust-proof and watertight.

CROSSING CONTROL ARM

- A. School buses may be equipped with a crossing control arm mounted on the right side of the front bumper. When opened, this arm shall extend in a line parallel to the body side and aligned with the right front wheel.
- B. All components of the crossing control arm and all connections shall be weatherproofed.
- C. The crossing control arm shall incorporate system connectors (electrical, vacuum or air) at the gate and shall be easily removable to allow for towing of the bus.
- D. The crossing control arm shall be constructed of non-corrodible or nonferrous material or shall be treated in accordance with the body sheet metal specification. (See BUS BODY AND CHASSIS SPECIFICATIONS, Metal Treatment.)
- E. There shall be no sharp edges or projections that could cause injury or be a hazard to students. The end of the arm shall be rounded.
- F. The crossing control arm shall extend a minimum of 70 inches (measured from the bumper at the arm assembly attachment point) when in the extended position. The crossing control arm shall not extend past the end of the bumper when in the

- stowed position.
- G. The crossing control arm shall extend simultaneously with the stop signal arm(s), activated by stop signal arm controls.
 - H. An automatic recycling interrupt switch shall be installed for temporarily disabling the crossing control arm.
 - I. The assembly shall include a device attached to the bumper near the end of the arm to automatically retain the arm while in the stowed position. That device shall not interfere with normal operations of the crossing control arm.

DEFROSTERS

- A. Defrosting and defogging equipment shall direct a sufficient flow of heated air onto the windshield, the window to the left of the driver, and the glass in the viewing area directly to the right of the driver to eliminate frost, fog and snow. (**Exception:** The requirements of this standard do not apply to the exterior surfaces of double pane storm windows.)
- B. The defrosting system shall conform to SAE J381, *Windshield Defrosting Systems Test Procedure and Performance Requirements—Trucks, Buses, and Multipurpose Vehicles*.
- C. The defroster and defogging system shall be capable of furnishing heated, outside ambient air, except that the part of the system furnishing additional air to the windshield, entrance door and stepwell may be the re-circulating air type.
- D. Auxiliary fans are not considered defrosting or defogging systems.
- E. Portable heaters shall not be used.

DOORS

- A. The entrance door shall be under the driver's control, designed to afford easy release and to provide a positive latching device on manual operating doors to prevent accidental opening. When a hand lever is used, no part shall come together that will shear or crush fingers. Manual door controls shall not require more than 25 pounds of force to operate at any point throughout the range of operation, as tested on a 10% grade, both uphill and downhill.
- B. The primary entrance door shall be located on the right side of the bus, opposite and within direct view of the driver.
 - 1. In addition, buses may be equipped with a left side entrance door located immediately behind the driver to be used exclusively for curb side loading/unloading on one-way streets.
 - 2. Buses equipped with a left side entrance door shall have a mirror mounted in the upper right corner of the interior of the bus so as to provide a clear view of the left side entrance door and stepwell.
- C. The entrance door shall have a minimum horizontal opening of 24 inches and a minimum vertical opening of 68 inches.
- D. The entrance door shall be a split-type door and shall open outward.
- E. All entrance door glass shall be approved safety glass. The bottom of each lower glass panel shall be not more than 10 inches from the top surface of the bottom step. The top of each upper glass panel when viewed from the interior shall be not more than three inches below the interior door control cover or header pad.

- F. Vertical closing edges on entrance doors shall be equipped with flexible material.
- G. All door openings shall be equipped with padding at the top edge of the opening.
Padding shall be at least three inches wide and one inch thick and extend the full width of the door opening.
- H. On power-operated entrance doors, the emergency release valve, switch or device to release the entrance door must be placed above or to the immediate left or immediate right of the entrance door and must be clearly labeled. The emergency release valve, switch or device shall work in the absence of power.

DRIVE SHAFT

The drive shaft shall be protected by a metal guard or guards around the circumference of the drive shaft to reduce the possibility of its whipping through the floor or dropping to the ground if broken.

ELECTRICAL SYSTEM

A. Battery

1. The storage batteries shall have minimum cold cranking capacity rating (cold cranking amps) equal to the cranking current required for 30 seconds at 0 degrees Fahrenheit and a minimum reserve capacity rating of 120 minutes at 25 amps. Higher capacities may be required depending upon optional equipment and local environmental conditions.
2. The manufacturer shall securely attach the battery on a slide-out or swingout tray in a closed, vented compartment in the body skirt or chassis frame so that the battery is accessible for convenient servicing from the outside. When in the stored position, the tray shall be retained by a securing mechanism capable of holding the tray [with battery(ies)] in position when subjected to a 5g load from any direction. The battery compartment door or cover, if separate from the tray, shall be hinged at the front or top. It shall be secured by a positive operated latching system or other type fastener. The door may be an integral part of the battery slide tray. The door or cover must fit tightly to the body and not present sharp edges or snagging points. Battery cables shall meet SAE requirements. Battery cables shall be of sufficient length to allow the battery tray to fully extend. Any chassis frame mounted batteries shall be relocated to a battery compartment on Type A buses.
3. All batteries are to be secured in a sliding tray except that on van conversion or cutaway front-section chassis batteries may be secured in accordance with the manufacturer's standard configuration. In these cases, the final location of the battery and the appropriate cable lengths shall be agreed upon mutually by the chassis and body manufacturers. However, in all cases the battery cable provided with the chassis shall have sufficient length to allow some slack and shall be of sufficient gauge to carry the required amperage.
4. Buses may be equipped with a battery shut-off switch. The switch is to be placed in a location not readily accessible to the driver or passengers.

B. Alternator

1. All Type A-2 and Type B buses with a GVWR of 15,000 pounds or less shall have a minimum 130-amp alternator. Buses equipped with an electrically powered wheelchair lift and/or air conditioning shall be equipped with the highest rated capacity available from the chassis OEM.
2. All buses over 15,000 pounds GVWR shall be equipped with a heavy-duty truck- or bus-type alternator having a minimum output rating of 240 amps or higher and should produce a minimum current output of 50 percent of the rating at engine idle speed.
3. Buses equipped with an electrically powered wheelchair lift, and/or air conditioning may be equipped with a device that advances the engine idle speed when the voltage drops to, or below, a pre-set level.
4. A belt-driven alternator shall be capable of handling the rated capacity of the alternator with no detrimental effect on any other driven components. (For estimating required alternator capacity, see School Bus Manufacturers Technical Council's publication, "School Bus Technical Reference," available at <http://www.nasdpts.org>.)
5. A direct/gear-drive alternator is permissible in lieu of a belt-driven alternator.

C. Electrical Components

Materials in all electrical components shall contain no mercury.

D. Wiring, Chassis

1. All wiring shall conform to current applicable recommended practices of the Society of Automotive Engineers (SAE). All wiring shall use color and at least one other method for identification. The other method shall be either a number code or name code, and each chassis shall be delivered with a wiring diagram that illustrates the wiring of the chassis.
2. The chassis manufacturer of an incomplete vehicle shall install a readily accessible terminal strip or connector on the body side of the cowl or in an accessible location in the engine compartment of vehicles designed without a cowl. The strip or connector shall contain the following terminals for the body connections:
 - a. Main 100-amp body circuit,
 - b. Tail lamps,
 - c. Right turn signal,
 - d. Left turn signal,
 - e. Stop lamps,
 - f. Back-up lamps, and
 - g. Instrument panel lamps (controlled by dimmer switch).
3. An appropriate identifying diagram (color plus a name or number code) for all chassis electrical circuits shall be provided to the body manufacturer for distribution to the end user.
4. Wiring for the headlamp system must be separate from the electronic controlled body solenoid/module.

E. Wiring, Body

1. All wiring shall conform to current SAE standards.
2. All wiring shall have an amperage capacity exceeding the design load by at least 25%. All wiring splices are to be accessible and noted as splices on the wiring diagram.
3. A body wiring diagram, sized to be easily read, shall be furnished with each bus body or affixed to an area convenient to the electrical accessory control panel.
4. The body power wire shall be attached to a special terminal on the chassis.
5. Each wire passing through metal openings shall be protected by a grommet.
6. Wires not enclosed within the body shall be fastened securely at intervals of not more than 18 inches. All joints shall be soldered or joined by equally effective connectors, which shall be water-resistant and corrosion resistant.
7. Wiring shall be arranged in circuits, as required, with each circuit protected by a fuse breaker or electronic protection device. A system of color and number-coding shall be used, and an appropriate identifying diagram shall be provided to the end user, along with the wiring diagram provided by the chassis manufacturer. The wiring diagrams shall be specific to the bus model supplied and shall include any changes to wiring made by the body manufacturer. Chassis wiring diagrams shall be supplied to the end user. The following body interconnecting circuits shall be color-coded, as noted:

FUNCTION COLOR

- Left Rear Directional Lamp Yellow
- Right Rear Directional Lamp Dark Green
- Stop Lamps Red
- Back-up Lamps Blue
- Tail Lamps Brown
- Ground White
- Ignition Feed, Primary Feed Black

The color of the cables shall correspond to SAE J1128, *Low-Tension Primary Cable*.

8. Wiring shall be arranged in at least six regular circuits, as follows:
 - a. Head, tail, stop (brake), clearance and instrument panel lamps;
 - b. Step well lamps shall be actuated when the entrance door is open;
 - c. Dome lamps;
 - d. Ignition and emergency door signal;
 - e. Turn signal lamps; and
 - f. Alternately flashing signal lamps.
9. Any of the above combination circuits may be subdivided into additional independent circuits.
10. Heaters and defrosters shall be wired on an independent circuit.
11. Whenever possible, all other electrical functions (such as sanders and electric-type windshield wipers) shall be provided with independent and

- properly protected circuits.
12. Each body circuit shall be coded by number or letter on a diagram of circuits and shall be attached to the body in a readily accessible location.
- F. Buses shall be equipped with a 12-volt power port in the driver's area.
- G. A manual noise suppression switch shall be installed in the control panel. The switch shall be labeled and alternately colored. This switch shall be an on/off type that deactivates body equipment that produces noise, including at least the AM/FM radio, heaters, air conditioners, fans and defrosters. This switch shall not deactivate safety systems, such as windshield wipers or lighting systems.
- H. The entire electrical system of the body shall be designed for the same voltage as the chassis on which the body is mounted.

EMERGENCY EQUIPMENT

A. Fire extinguisher

1. The bus shall be equipped with at least one 5 lb. UL-approved pressurized, dry chemical fire extinguisher. The extinguisher shall be secured in a mounted bracket, located in the driver's compartment and readily accessible to the driver and passengers. A pressure gauge shall be mounted on the extinguisher and shall be easily read without moving the extinguisher from its mounted position.
2. The fire extinguisher shall have a rating of 2-A:10-BC or greater. The operating mechanism shall be secured with a type of seal that will not interfere with the use of the fire extinguisher.

B. First aid kit

1. The bus shall have a removable, moisture-proof and dust-proof first aid kit in an accessible place in the driver's compartment. It shall be mounted and identified as a first aid kit. The location for the first aid kit shall be marked. Contents of the first aid kit shall be in compliance with state standards.
2. Suggested contents include:
 - 2 – 1-inch x 2½ yards of adhesive tape rolls
 - 24 – Sterile gauze pads 3x3 inches
 - 100 – ¾ x 3 inches adhesive bandages
 - 8 – 2-inch bandage compress
 - 10 – 3-inch bandage compress
 - 2 – 2-inch x 6 feet sterile gauze roller bandages
 - 2 – Non-sterile triangular bandages, minimum 39x35x54 inches with two safety pins
 - 3 – Sterile gauze pads 36x36 inches
 - 3 – Sterile eye pads
 - 1 – Rounded-end scissors
 - 1 – Pair medical examination gloves
 - 1 – Mouth-to-mouth airway

C. Body fluid clean-up kit

Each bus shall have a removable and moisture-proof body fluid clean-up kit accessible to the driver. It shall be mounted and identified as a body fluid cleanup

kit. Minimum contents of the body fluid clean up kit shall be:

- 1 bio hazard bag with tie, 7-10 gal
- 1 pr. gloves – nitrile
- 1 bag with scoop and small scraper
- 2 oz. absorbent powder
- 1 mask – dust
- paper towel
- antiseptic towelettes
- cleanser
- 1 black/brown plastic bag
- instructions

D. Warning devices

Each school bus shall contain at least three retro reflective triangle road warning devices that meet the requirements of FMVSS No. 125, *Warning Devices*. They shall be mounted in an accessible place.

E. Any piece of emergency equipment may be mounted in an enclosed compartment, provided the compartment is labeled in not less than one inch letters, identifying each piece of equipment contained therein.

EMERGENCY EXITS

A. Any installed emergency exit shall comply with the design and performance required by FMVSS No. 217, *Bus Emergency Exits and Window Retention and Release*, applicable to that type of exit, regardless of whether or not that exit is required by FMVSS No. 217.

B. Emergency window requirements

1. The rear emergency window shall have a lifting assistance device that will aid in lifting and holding the rear emergency window open.
2. Side emergency exit windows, when installed, may be vertically hinged on the forward side of the window. No side emergency exit window will be located above a stop arm.

C. Emergency door requirements

1. The exposed area of the upper panel of emergency doors shall be a minimum of 400 square inches of approved safety glazing. If installed, all other glass panels on emergency doors shall be approved safety glazing.
2. There shall be no steps leading to an emergency door.
3. Padding shall be affixed to the top edge of each emergency door opening. Padding shall be at least three inches wide and one inch thick and shall extend the full width of the door opening.
4. There shall be no obstruction higher than $\frac{1}{4}$ inch across the bottom of any emergency door opening. Fasteners used within the emergency exit opening shall be free of sharp edges or burrs.

D. Emergency exit requirements: The use of the following tables is to determine the required number and types of emergency exits to comply with this specification, based on the bus manufacturer's equipped seating capacity.

1. Use **Table 1** if the bus contains a rear emergency door, or

2. Use **Table 2** if the bus contains a rear pushout emergency window AND a left side emergency door, as required by FMVSS No. 217 for school buses without a rear emergency door.
3. When using either Table 1 or Table 2:
 - a. Enter the Table at the appropriate “CAPACITY” and select the desired row from the options for that capacity.
 - b. A school bus will meet the requirements of this specification and the requirements of FMVSS 217 if it contains the types and quantities of emergency exits listed on the row selected.

TABLE 1 BUSES WITH REAR EMERGENCY DOOR (All Front Engine Buses)						TABLE 2 BUSES WITH REAR PUSHOUT WINDOW AND LEFT SIDE EMERGENCY DOOR (All Rear Engine Buses)					
Available Combinations By Capacity	Manufacturers Equipped Capacity	Shall Have	And Shall Also Have			Available Combinations By Capacity	Manufacturers Equipped Capacity	Shall Have	And Shall Also Have		
		Roof Hatch	L. Side Emerg. Exit Windows	R. Side Emerg. Exit Windows	L. Side Emerg. Exit Door			Roof Hatch	L. Side Emerg. Exit Windows	R. Side Emerg. Exit Windows	R. Side Emerg. Exit Door
1-45	1-45	1	0	0	0	1-45	1-45	1	0	0	0
46-77	46-77	2	1	1	0	46-89	46-89	2	1	1	0
	46-77	2	0	0	1		46-89	2	0	0	1
78-93	78-93	2	2	2	0	90-105	90-105	2	2	2	0
	78-93	2	1	1	1		90-105	2	1	1	1

EXHAUST SYSTEM

- A. The exhaust pipe, after-treatment system and tailpipe shall be outside the bus body compartment and shall be attached to the chassis so any other chassis component is not damaged.
- B. The tailpipe and after-treatment system shall be constructed of a corrosion resistant tubing material at least equal in strength and durability to 16-gauge steel tubing of equal diameter.
- C. The tailpipe may be flush with, or shall not extend more than two inches beyond, the perimeter of the body for side-exit pipe or the bumper for rear-exit pipe. The exhaust system shall be designed such that exhaust gas will not be trapped under the body of the bus.
- D. The tailpipe shall exit to the left or right of the emergency exit door in the rear of the vehicle or to the left side of the bus in front of or behind the rear drive axle. The tailpipe may extend through the bumper. The tailpipe exit location on all Types A-1 or B-1 buses may be in accordance to the manufacturer’s standards. The tailpipe shall not exit beneath any fuel filler location, emergency door or lift door.
- E. The exhaust system shall be insulated in a manner to prevent any damage to any fuel system component.
- F. The design of the after treatment systems shall not allow active (non-manual)

regeneration of the particulate filter during the loading and unloading of passengers. Manual regeneration systems will be designed such that unintentional operation will not occur.

- G. For after treatment systems that require Diesel Exhaust Fluid (DEF) to meet federally mandated emissions:
1. The composition of Diesel Exhaust Fluid (DEF) must comply with International Standard ISO 22241-1. Refer to engine manufacturer for any additional DEF requirements.
 2. The DEF supply tank shall be sized to meet a minimum ratio of 3 diesel fills to 1 DEF fill.

FENDERS: FRONT

- A. When measured at the fender line, the total spread of the outer edges of front fenders shall exceed the total spread of front tires when front wheels are in a straight-ahead position.
- B. Front fenders shall be properly braced and shall not require attachment to any part of the body.

FIRE SUPPRESSION SYSTEMS (OPTIONAL)

- A. The chassis manufacturer may provide an automatic fire extinguisher system in the engine compartment.
- B. Fire suppression system nozzles shall be located in the engine compartment, under the bus, in the electrical panel, or under the dash, but they shall not be located in the passenger compartment. The system must include a lamp or buzzer to alert the driver that the system has been activated.

FLOORS

- A. The floor in the under-seat area, including tops of wheel housings, driver's compartment and toeboard, shall be covered with an elastomer floor covering, having a minimum overall thickness of .125 inch and a calculated burn rate of 0.1 mm per minute or less, using the test methods, procedures and formulas listed in FMVSS No. 302, *Flammability of Interior Materials*. The driver's area and toeboard area in all Type-A buses may be manufacturer's standard flooring and floor covering.
- B. The floor covering in the aisles shall be ribbed or other raised pattern elastomer and have a calculated burn rate of 0.1 mm per minute or less using the test methods, procedures and formulas listed in FMVSS No. 302. Minimum overall thickness shall be .187 inch measured from tops of ribs.
- C. The floor covering must be permanently bonded to the floor and must not crack when subjected to sudden changes in temperature. Bonding or adhesive material shall be waterproof and shall be a type recommended by the manufacturer of floor-covering material. All seams shall be sealed with waterproof sealer.
- D. On Types B, C and D buses, a flush-mounted, screw-down plate that is secured and sealed shall be provided to access the diesel or gasoline fuel tank sending unit and/or fuel pump. This plate shall not be installed under flooring material.

FRAME

- A. Frame lengths shall be established in accordance with the design criteria for the complete vehicle.
- B. Making holes in top or bottom flanges or side units of the frame and welding to the frame shall not be permitted except as provided or accepted by the chassis manufacturer.
- C. Frames shall not be modified for the purpose of extending the wheel base.
- D. Any secondary manufacturer that modifies the original chassis frame shall provide a warranty at least equal to the warranty offered by the original equipment manufacturer (OEM) and shall certify that the modification and other parts or equipment affected by the modification are free from defects in material and workmanship under normal use and service intended by the OEM.

FUEL SYSTEM

- A. Fuel tank(s) having a minimum 25-gallon capacity shall be provided by the chassis manufacturer. Each tank shall be filled from and vented to the outside of the passenger compartment, and each fuel filler should be placed in a location where accidental fuel spillage will not drip or drain on any part of the exhaust system.
- B. The fuel system shall comply with FMVSS No. 301, *Fuel System Integrity*.
- C. Fuel tank(s) may be mounted between the chassis frame rails or outboard of the frame rails on either the left or right side of the vehicle.
- D. The actual draw capacity of each fuel tank shall be a minimum of 83 percent of the tank capacity.
- E. Installation of alternative fuel systems, including fuel tanks and piping from the tank to the engine, shall comply with all applicable fire codes in effect on the date of manufacture of the bus.
- F. Installation of Liquefied Petroleum Gas (LPG) tanks shall comply with National Fire Protection Association (NFPA) 58, *Liquefied Petroleum Gas Code*.
- G. Installation of Compressed Natural Gas (CNG) containers shall comply with FMVSS No. 304, *Compressed Natural Gas Fuel Container Integrity*.
- H. The CNG Fuel System shall comply with FMVSS No. 303, *Fuel System Integrity of Compressed Natural Gas Vehicles*.

GOVERNOR

An electronic engine speed limiter shall be provided and set to limit engine speed, not to exceed the maximum revolutions per minute, as recommended by the engine manufacturer.

HANDRAILS

Two handrails shall be installed. The handrails shall be a minimum of 1" diameter, and be constructed from corrosion resistant material(s). The handrails shall assist passengers during entry or exit and shall be designed to prevent entanglement, as evidenced by the passing of the NHTSA string and nut test.

HEATING SYSTEM, PROVISION FOR

The chassis engine shall have plugged openings for the purpose of supplying hot water

for the bus heating system. The engine shall be capable of supplying coolant at a temperature of at least 170 degrees Fahrenheit at the engine coolant thermostat opening. The coolant flow rate shall be 50 pounds per minute at the return end of 30 feet of one inch inside diameter automotive hot water heater hose. (See SBMTC-001, *Standard Code for Testing and Rating Automotive Bus Hot Water Heating and Ventilating Equipment*.)

HEATING AND AIR CONDITIONING SYSTEMS

A. Heating System

1. The heater shall be hot water ~~and/or~~ combustion type, electric heating element, or heat pump.
2. If only one heater is used, it shall be fresh-air or combination fresh-air and recirculation type.
3. If more than one heater is used, additional heaters may be re-circulating air type.
4. The heating system shall be capable of maintaining bus interior temperatures, as specified in test procedure SAE J2233.
5. Auxiliary fuel-fired heating systems are permitted, provided they comply with the following:
 - a. The auxiliary heating system shall utilize the same type fuel as specified for the vehicle engine.
 - b. The heater(s) may be direct, hot air-type or may be connected to the engine coolant system.
 - c. An auxiliary heating system, when connected to the engine coolant system, may be used to preheat the engine coolant or preheat and add supplementary heat to the heating system.
 - d. Auxiliary heating systems must be installed pursuant to the manufacturer's recommendations and shall not direct exhaust in such a manner that will endanger bus passengers.
 - e. All combustion heaters shall be in compliance with current Federal Motor Carrier Safety Regulations.
 - f. The auxiliary heating system shall require low voltage.
 - g. Auxiliary heating systems shall comply with FMVSS No. 301, *Fuel System Integrity*, and all other applicable FMVSS's, as well as with SAE test procedures.
6. All forced-air heaters installed by body manufacturers shall bear a name plate that indicates the heater rating in accordance with SBMTC-001, *Standard Code for Testing and Rating Automotive Bus Hot Water Heating and Ventilating Equipment*. The plate shall be affixed by the heater manufacturer and shall constitute certification that the heater performance is as shown on the plate.
7. Heater hoses shall be adequately supported to guard against excessive wear due to vibration. The hoses shall not dangle or rub against the chassis or any sharp edges and shall not interfere with or restrict the operation of any engine function. Heater hoses shall conform to SAE J20c, *Coolant*

System Hoses. Heater lines, cores, and elements on the interior of the bus shall be shielded to prevent scalding or burning of the driver or passengers.

8. Each hot water system installed by a body manufacturer shall include one shutoff valve in the pressure line and one shut-off valve in the return line with both valves at the engine in an accessible location, except that on Types A and B buses the valves may be installed in another accessible location.
9. All heaters of hot water type in the passenger compartment shall be equipped with a device, installed in the hot water pressure line, which regulates the water flow to all passenger heaters. The device shall be conveniently operated by the driver while seated. The driver and passenger heaters may operate independently of each other for maximum comfort.
10. Accessible bleeder valves of hot water type systems, for removing air from the heater shall be installed in an appropriate place in the return lines of body company installed heater.
11. Access panels shall be provided to make heater motors, cores, elements, and fans readily accessible for service. An exterior access panel to the driver's heater may be provided.

B. Passenger Compartment Air Conditioning (Optional)

The following specifications are applicable to all types of school buses that may be equipped with air conditioning. This section is divided into three parts. Part 1 covers performance specifications, Part 2 covers test conditions and Part 3 covers other requirements applicable to all buses.

1. Performance Specifications

a. Standard Performance

The installed air conditioning system should cool the interior of the bus from 100 degrees to 80 degrees Fahrenheit measured at three points (minimum) located four feet above the floor on the longitudinal centerline of the bus. The three required points shall be: (1) three feet above the center point of the horizontal driver seat surface, (2) at the longitudinal midpoint of the body, and (3) three feet forward of the rear emergency door or, for Type D rear-engine buses, three feet forward of the end of the aisle. Note for the Type A vehicles placement of the rear thermocouple should be centered in the bus over the rear axle. The independent temperature reading of each temperature probe inside the bus shall be within a range of +/- 3 degrees Fahrenheit of the average temperature at the conclusion of the test.

b. High Performance

The installed air conditioning system should cool the interior of the bus from 100 degrees to 70 degrees Fahrenheit, measured at three points (minimum) located four feet above the floor on the longitudinal centerline of the bus. The three required points shall be: (1) three feet above the center point of the horizontal driver seat surface, (2) at the longitudinal midpoint of the body, and (3)

three feet forward of the rear emergency door or, for Type D rear-engine buses, three feet forward of the end of the aisle. Note for the Type A vehicles placement of the rear thermocouple should be centered in the bus over the rear axle. The independent temperature reading of each temperature probe inside the bus shall be within a range of +/- 3 degrees Fahrenheit of the average temperature at the conclusion of the test.

2. Test Conditions

The test conditions under which the above performance standards must be achieved shall consist of (1) placing the bus in a room (such as a paint booth) where ambient temperature can be maintained at 100 degrees Fahrenheit; (2) heat-soaking the bus at 100 degrees Fahrenheit at a point measured two feet horizontally from the top of the windows on both sides of the bus with windows open for two hours; and (3) closing windows, turning on the air conditioner with the engine running at 1250 +/- 50 RPM, and cooling the interior of the bus to 80 degrees Fahrenheit (standard performance) or 70 degrees Fahrenheit (high performance) within 30 minutes while maintaining 100 degrees Fahrenheit outside temperature. The manufacturer shall provide test results that show compliance of standard systems. If the bid specifies, the manufacturer shall provide facilities for the user or user's representative to confirm that a pilot model of each bus design meets the above performance requirements.

3. Other Requirements

- a. Evaporator cases, lines and ducting (as equipped) shall be designed in such a manner that all condensation is effectively drained to the exterior of the bus below the floor level under all conditions of vehicle movement and without leakage on any interior portion of the bus.
- b. Evaporators and ducting systems shall be designed and installed to be free of projections or sharp edges. Ductwork shall be installed so that exposed edges face the front of the bus and do not present sharp edges.
- c. On school buses equipped with Type-2 seatbelts having anchorages above the windows, the ducting (if used) shall be placed at a height sufficient not to obstruct occupant securement anchorages. This clearance shall be provided along the entire length (except at evaporator locations) of the passenger area on both sides of the bus interior.
- d. The body may be equipped with insulation, including sidewalls, roof, firewall, rear, inside body bows, and plywood or composite floor insulation to reduce thermal transfer.
- e. Electrical generating capacity shall be provided to accommodate the additional electrical demands imposed by the air conditioning system.
- f. Air intake for any evaporator assembly(ies), except for front

- evaporator of Type A-1, shall be equipped with replaceable air filter(s) accessible without disassembly of evaporator case.
- g. For all buses (except Type D rear engine transit) equipped with a rear evaporator assembly, evaporator shall not encroach upon head impact zone but may occupy an area of less than 26.5 inches from the rear wall and 14 inches from the ceiling.
 - h. For Type D rear engine transit buses equipped with a rear evaporator over the davenport, the evaporator assembly may not interfere with rear exit window and may not extend above the rear seating row.

HINGES

All exterior metal door hinges shall be designed to allow lubrication to be channeled to the center 75% of each hinge loop without disassembly, unless they are constructed of stainless steel, brass or non-metallic hinge pins or other designs that prevent corrosion.

HORN

The bus shall be equipped with a horn(s) of standard make with the horn(s) capable of producing a complex sound in bands of audio frequencies between 250 and 2,000 cycles per second and tested in accordance with SAE J377, *Horn—Forward Warning—Electric—Performance, Test, and Application*.

IDENTIFICATION

- A. The body shall bear the words “SCHOOL BUS” in black letters at least eight inches high on both front and rear of the body or on signs attached thereto. Lettering shall be placed as high as possible without impairment of its visibility. Letters shall conform to “Series B” of Standard Alphabets for Highway Signs. “SCHOOL BUS” lettering shall have a reflective background or, as an option, may be illuminated by backlighting. MFSABs are exempt from these requirements.
- B. Required lettering and numbering shall include:
 - 1. District, company name or owner of the bus displayed at the beltline.
 - 2. The bus identification number displayed on the sides, on the rear and on the front.
 - 3. The vehicles seating capacity, GVWR, and height, which shall be placed in a conspicuous exterior location on the driver’s entry side of the bus close enough to the entry door for the driver to easily see the information.
 - a. Lettering will be in 2” block letters.
 - b. The height of the bus will be measured to the highest part of the bus including all accessories except antennas.
 - c. The height specified may be greater than the actual height of the bus provided it is not more than 6” higher than the actual height.
- C. Other lettering, numbering or symbols which may be displayed on the exterior of the bus shall be limited to:
 - 1. Bus identification number, minimum 12-inch high characters, on top of the bus, in addition to required numbering on the sides, rear and front;

2. The location of the battery(ies) identified by the word “BATTERY” or “BATTERIES” on the battery compartment door in two inch lettering;
3. Symbols or letters not to exceed 64 square inches of total display near the entrance door displaying information for identification by the students of the bus or route served;
4. Manufacturer, dealer or school identification or logos;
5. Symbols identifying the bus as equipped for or transporting students with special needs as noted in SPECIALLY EQUIPPED SCHOOL BUS SPECIFICATIONS;
6. Lettering on the rear of the bus relating to school bus flashing signal lamps or electronic warning sign.
7. Lettering relating to railroad stop procedures; and
8. Identification of fuel type in 1-inch lettering adjacent to the fuel filler opening.

INSIDE HEIGHT

Inside body height shall be 72 inches or more, measured metal to metal, at any point on the longitudinal centerline from the front vertical bow to the rear vertical bow. Inside body height of Type A-1 buses shall be 62 inches or more. Inside height measurement does not apply to air conditioning equipment.

INSTRUMENTS AND INSTRUMENT PANEL

- A. The chassis shall be equipped with the instruments and gauges listed below: (Telltale warning lamps in lieu of gauges are not acceptable, except as noted.)
 1. Speedometer;
 2. Odometer that can be read without using a key and that will give accrued mileage (to seven digits), including tenths of miles unless tenths of miles are registered on a trip odometer.
 3. Tachometer (**Note:** For types B, C and D buses, a tachometer shall be installed so as to be visible to the driver while seated in a normal driving position.);
 4. Voltmeter (**Note:** An ammeter with graduated charge and discharge indications is permitted in lieu of a voltmeter; however, when used, the ammeter wiring must be compatible with the current flow of the system.);
 5. Oil pressure gauge;
 6. Water temperature gauge;
 7. Fuel gauge;
 8. High beam headlamp indicator;
 9. Brake air pressure gauge (air brakes), brake indicator lamp (vacuum/ hydraulic brakes), or brake indicator lamp (hydraulic/hydraulic);
 10. Turn signal indicator; and
 11. Glow-plug indicator lamp, where appropriate.
- B. All instruments shall be easily accessible for maintenance and repair.
- C. The instruments and gauges shall be mounted on the instrument panel so that each is clearly visible to the driver while seated in a normal driving position.
- D. Instruments and controls must be illuminated as required by FMVSS No. 101,

Controls and Displays.

E. Multi-function gauge (MFG)

1. The driver must be able to manually select any displayable function of the gauge on a MFG, whenever desired.
2. Whenever an out-of-limits condition that would be displayed on one or more functions of a MFG occurs, the MFG controller should automatically display this condition on the instrument cluster. This should be in the form of an illuminated telltale warning lamp, as well as having the MFG automatically display the out-of-limits indications. If two or more functions displayed on the MFG go out of limits simultaneously, then the MFG should sequence automatically between those functions continuously until the condition(s) are corrected.
3. The use of an MFG does not relieve the need for audible warning devices where required.

INSULATION (OPTIONAL)

- A. If thermal insulation is specified, it shall be fire-resistant, UL approved, with minimum R-value of 5.5. Insulation shall be installed to prevent sagging.
- B. If floor insulation is required, it shall be five-ply softwood plywood, nominal $\frac{5}{8}$ inch thickness, and shall be equal to or exceed properties of the exterior-type, C-D Grade, as specified in the standard issued by U.S. Department of Commerce. When plywood is used, all exposed edges shall be sealed. Type A-1 buses may be equipped with nominal $\frac{1}{2}$ inch-thick plywood or equivalent material meeting the above requirements. Equivalent material may be used to replace plywood provided it has equal or greater insulation R-value, sound abatement, deterioration-resistant, and moisture resistant properties.

INTERIOR

- A. The interior of the bus shall be free of all unnecessary projections, which include luggage racks and attendant handrails, to minimize the potential for injury. This specification requires inner lining on ceilings and walls. If the ceiling is constructed with lap joints, the forward panel shall be lapped by rear panel, and exposed edges shall be beaded, hemmed, flanged or otherwise treated to minimize sharp edges. Buses may be equipped with a storage compartment for tools, tire chains, and/or tow chains. (See BUS BODY AND BODY SPECIFICATIONS, Storage Compartment.) MFSABs may use luggage racks provided they meet the requirements of FMVSS 222.
- B. Interior overhead storage compartments may be provided if they meet the following criteria:
 1. Head protection requirements of FMVSS No. 222, *School Bus Passenger Seating and Crash Protection*, where applicable;
 2. Completely enclosed and equipped with latching door (both door and latch sufficient to withstand a pushing force of 50 pounds applied at the inside center of the door);
 3. All corners and edges rounded with a minimum radius of one inch or be padded equivalent to door header padding;

4. Attached to the bus sufficiently to withstand a force equal to 20 times the maximum rated capacity of the compartment; and
 5. No protrusions greater than ¼ inch.
- C. The driver's area forward of the foremost padded barriers will permit the mounting of required safety equipment and vehicle operation equipment.
- D. Every school bus shall be constructed so that the noise level at the ear of the occupant nearest to the primary vehicle noise source shall not exceed 85 DBA when tested according to the procedure described in APPENDIX.
- E. On C and D type buses at least the front two ceiling sections of the bus will be perforated to increase noise absorption.

LAMPS AND SIGNALS

- A. Interior lamps which illuminate the aisle and the stepwell shall be provided. The stepwell lamp shall be illuminated by an entrance door-operated switch to illuminate only when headlamps and clearance lamps are on and the entrance door is open.
- B. Body instrument panel lamps may be controlled by an independent dimmer switch or may be controlled by the dimmer that operates the gauge lighting.
- C. School bus alternately flashing signal lamps shall be provided as described by law. MFSAB's are exempt from this requirement.
1. The bus shall be equipped with two red lamps at the rear of the vehicle and two red lamps at the front of the vehicle.
 2. In addition to the four red lamps described above, four amber lamps shall be installed so that one amber lamp is located near each red signal lamp at the same level but closer to the vertical centerline of the bus. The system of red and amber signal lamps shall be wired so that amber lamps are energized manually. The red lamps are automatically energized and amber lamps are automatically de-energized when stop signal arms are extended or when the bus entrance door is opened. The above mentioned activation sequence can be accomplished with either a "sequential operation" or a "non-sequential operation" warning lamp system. While each of the systems can be configured to include components such as a master switch, amber activation switch, interrupt switch, etc., the presence (or absence) of these components does not affect the classification of the system as either *sequential* or *non-sequential*. Both *sequential* and *non-sequential* systems can be configured with a multitude of switch combinations to provide a unique system meeting specific user requirements. An amber pilot lamp and a red pilot lamp shall be installed adjacent to the driver controls for the flashing signal lamp to indicate to the driver which lamp system is activated.
 3. In buses with power doors, the driver shall be able to activate the red signal lamp prior to opening the door. This is accomplished by having a door switch that has three positions. The first is closed. The second position is red warning lights engaged and amber lights off with the service door closed. The third position is red warning lights on and service door open.
 4. For background color requirements, refer to "Color."

5. Red lamps shall flash at any time the stop signal arm is extended.
 6. All flashers for alternately flashing red and amber signal lamps shall be enclosed in the body in a readily accessible location.
- D. Turn signal and stop/tail lamps
1. The bus body shall be equipped with amber rear turn signal lamps that are at least seven inches in diameter or, if a shape other than round, a minimum 38 square inches of illuminated area and shall meet FMVSS No. 108, *Lamps, Reflective Devices, and Associated Equipment*. These signal lamps must be connected to the chassis hazard warning switch to cause simultaneous flashing of turn signal lamps when needed as a vehicular traffic hazard warning. Turn signal lamps are to be placed as wide apart as practical, and their horizontal centerline shall be a maximum of 12 inches below the rear window.
 2. Buses shall be equipped with amber side-mounted turn signal lamps. The turn signal lamp on the left side shall be mounted rearward of the stop signal arm and the turn signal lamp on the right side shall be mounted rearward of the entrance door.
 3. Buses shall be equipped with four combination red stop/tail lamps.
 - a. Two combination lamps with a minimum diameter of seven inches, or if a shape other than round, a minimum 38 square inches of illuminated area shall be mounted on the rear of the bus just inside the turn signal lamps.
 - b. Two combination lamps with a minimum diameter of four inches, or if a shape other than round, a minimum of 12 square inches of illuminated area shall be placed on the rear of the body between the beltline and the floor line. The rear license plate lamp may be combined with one lower tail lamp. Stop lamps shall be activated by the service brakes and shall emit a steady light when illuminated.
- E. On buses equipped with a monitor for the front and rear lamps of the school bus, the monitor shall be mounted in full view of the driver. If the full circuit current passes through the monitor, each circuit shall be protected against any short circuit or intermittent shorts by a fuse circuit breaker, or electronic protection device.
- F. An optional white flashing strobe lamp may be installed on the roof of a school bus at a location not closer than 12 inches or more than 6 feet from the rear of the roof edge. However, if the bus is equipped with a roof hatch, or other roof mounted equipment, falling within the above mentioned measurements, the strobe lamp may be located directly behind that equipment. The lamp shall have a single clear lens emitting light 360 degrees around its vertical axis meeting the requirements of SAE J845. It may not extend above the roof more than the maximum legal height. A manual switch and a pilot lamp shall be included to indicate when the lamp is in operation. Optionally, the strobe lamp may be wired to activate with the amber alternately flashing signal lamps, continuing through the full loading or unloading cycle; and may be equipped with an override switch to allow activation of the strobe at any time for use in inclement weather.

- G. The bus body shall be equipped with two white rear backup lamps that are at least four inches in diameter or, if a shape other than round, a minimum of 12 square inches of illuminated area and shall meet FMVSS No. 108. If backup lamps are placed on the same horizontal line as the brake lamps and turn signal lamps, they shall be to the inside.
- H. A daytime running lamps (DRL) system shall be provided.
- I. All body signaling exterior lights including red and amber flashers except headlights, back-up lights and signaling lights mounted integrally with the headlights shall be LED. Additionally any lights on a Type A Bus chassis may be excepted if the OEM does not provide an LED option. Note: Back-up lights may be LED.

METAL TREATMENT

- A. All metal except high-grade stainless steel or aluminum used in construction of the bus body shall be zinc-coated or aluminum-coated or treated to prevent corrosion. This includes, but is not limited to, such items as structural members, inside and outside panels, door panels, and floor sills. Excluded are such items as door handles, grab handles, interior decorative parts, and other interior plated parts.
- B. All metal parts that will be painted, in addition to the above requirements, shall be chemically cleaned, etched, zinc phosphate-coated, and zinc chromate or epoxy primed to improve paint adhesion. This includes, but is not limited to, such items as crossing control arm and stop arm.
- C. In providing for these requirements, particular attention shall be given to lapped surfaces, welded connections of structural members, cut edges on punched or drilled hole areas in sheet metal, closed or box sections, un-vented or un-drained areas, and surfaces subjected to abrasion during vehicle operation.
- D. As evidence that the above requirements have been met, samples of materials and sections used in the construction of the bus body shall be subjected to cyclic corrosion testing as outlined in SAE J1563.

MIRRORS

- A. The interior glass mirror shall be either laminated or tempered and shall have rounded corners and protected edges. Mirrors shall be 6x16 inches minimum for Type A buses and 6x30 inches minimum for Types C and D buses.
- B. Each school bus shall be equipped with exterior mirrors meeting the requirements of FMVSS No. 111, *Rearview Mirrors*. The right side rear view mirror shall not be obscured by the unwiped portion of the windshield. Mirrors shall be easily adjustable but shall be rigidly braced to reduce vibration.
- C. Heated external mirrors shall be used.
- D. Remote controlled external rear view mirrors shall be used.

MOUNTING

- A. The rear body cross member shall be supported by the chassis frame. Except where chassis components interfere, the bus body shall be attached to the chassis frame at each main floor sill in such a manner as to prevent shifting or separation of the body from the chassis under severe operating conditions.

- B. Isolators shall be installed at all contact points between the body and the chassis frame on Types A-2, B, C and D buses and shall be secured by a positive means to the chassis frame or body to prevent shifting, separation, or displacement of the isolators under severe operating conditions.

OIL FILTER

An oil filter with a replaceable element shall be provided and connected by flexible oil lines if it is not a built-in or an engine-mounted design. The oil filter shall have a capacity in accordance with the engine manufacturer's recommendation.

OPENINGS

All openings in the floorboard or firewall between the chassis and the passenger compartment (e.g., for gearshift selector and parking brakes lever) shall be sealed.

OVERALL LENGTH

Overall length of the bus shall not exceed 45 feet, excluding accessories.

OVERALL WIDTH

Overall width of bus shall not exceed 102 inches, excluding accessories.

PASSENGER ADVISORY SYSTEM

- A. Each school bus shall be equipped with a "PASSENGER ADVISORY" system that is armed when the red lights are turned on at the first passenger stop. The system will require the driver to walk to the rearmost interior of the bus after each trip to deactivate the system via push button and to ensure that no passengers are left on the bus. The system shall sound the vehicle horn and flash the headlights if the driver fails to deactivate the system within 60 seconds of turning the ignition off. Type A1 buses may activate the red pupil warning lights in lieu of the headlights.
- B. The system must not affect or interfere with any other existing operating or electrical component (e.g., turn signals, brake lights, stop signal arm, etc.)
- C. The system must permit the driver complete control of the ignition switch and not interfere with engine operation or shutdown.
- D. The system may emit a reminder tone or signal during delay period.
- E. The system shall not have a bypass.
- F. The system shall be deactivated by the use of a heavy-duty push button placed on the left (position as determined from the normal driving position as seated in the driver's seat looking in the direction of forward travel roadside "driver side") rear bulkhead or above the left (roadside "driver side") rear passenger window for Type A, B, C, and D FE buses. The push button shall be placed above the left rear passenger window for Type D RE buses. This button shall be clearly marked.

PASSENGER LOAD

- A. Actual gross vehicle weight (GVW) is the sum of the chassis weight plus the body weight, plus the driver's weight, plus total seated student weight. For purposes of calculation, the driver's weight is 150 pounds and the student weight is 120 pounds per student.

- B. Actual GVW shall not exceed the chassis manufacturer's GVWR for the chassis, nor shall the actual weight carried on any axle exceed the chassis manufacturer's Gross Axle Weight Rating (GAWR).

PUBLIC ADDRESS SYSTEM

- A. Buses may be equipped with an AM/FM/audio and/or public address system having interior and exterior speakers.
- B. No internal speakers, other than the driver's communication systems, may be installed within four feet of the driver's seat back in its rearmost upright position.

RETARDER SYSTEM (OPTIONAL EQUIPMENT)

A retarder system, if used, shall limit the speed of a fully loaded school bus to 19.0 mph on a seven percent grade for 3.6 miles.

RETROREFLECTIVE MATERIAL

(See also APPENDIX, Retro reflective Sheeting and APPENDIX A in *National School Transportation Specifications and Procedures 2010*)

- A. The front and/or rear bumper may be marked diagonally 45 degrees down toward the centerline of the pavement with two \pm ¼-inch wide strips of non-contrasting retro reflective material.
- B. The rear of the bus body shall be marked with strips of retroreflective NSBY material to outline the perimeter of the back of the bus using material which conforms with the requirements of FMVSS No. 131, *School Bus Pedestrian Safety Devices*, Table 1. The perimeter marking of rear emergency exits per FMVSS No. 217, *Bus Emergency Exits and Window Retention and Release*, and/or the use of retro reflective "SCHOOL BUS" signs partially accomplishes the objective of this requirement. To complete the perimeter marking of the back of the bus, strips of retro reflective NSBY material, a minimum of one inch and a maximum of two inches in width, shall be applied horizontally above the rear windows and above the rear bumper, extending from the rear emergency exit perimeter and marking outward to the left and right rear corners of the bus. Vertical strips shall be applied at the corners connecting these horizontal strips. Multifunction School Activity Buses (MFSABs) shall be exempt from these color requirements.
- C. "SCHOOL BUS" signs, if not a lighted design, shall be marked with retroreflective NSBY material comprising background for lettering of the front and/or rear "SCHOOL BUS" signs.
- D. Sides of the bus body shall be marked with at least 1¾-inch retroreflective NSBY material, extending the length of the bus body and located (vertically) between the floor line and the beltline.
- E. If used, signs placed on the rear of the bus relating to school bus flashing signal lamps or railroad stop procedures may be retroreflective material as specified by each state.

ROAD SPEED CONTROL

When accurate control of vehicle maximum speed is desired, a vehicle speed limiter

may be utilized.

RUB RAILS

- A. There shall be one rub rail on each side of the bus located at, or no more than eight inches above, the seat cushion level. They shall extend from the rear side of the entrance door completely around the bus body (except at the emergency door or any maintenance access door) to the point of curvature near the outside cowl on the left side.
- B. There shall be one additional rub rail on each side located 10 inches or less above the floor line. The rub rail shall cover the same longitudinal span as the upper rub rail, except at the wheel housing, and it shall extend only to the longitudinal tangent of the right and left rear corners.
- C. Rub rails above the floor line shall be attached at each body post and at all other upright structural members.
- D. Each rub rail shall be four inches or more in width in its finished form and shall be constructed of 16-gauge metal or other material of equivalent strength suitable to help protect body side panels from damage. Rub rails shall be constructed in corrugated or ribbed fashion.
- E. Rub rails shall be applied outside the body or outside the body posts. (Pressed-in or snap-on rub rails do not satisfy this requirement.) For Type A-1 vehicles using the body provided by the chassis manufacturer or for Types A-2, B, C and D buses containing the rear luggage or the rear engine compartment, rub rails need not extend around the rear corners.
- F. The bottom edge of the body side skirts shall be stiffened by application of a rub rail, or the edge may be stiffened by providing a flange or other stiffeners.

SEATS AND RESTRAINING BARRIERS

A. Passenger Seating

- 1. School bus design capacities shall be in accordance with 49 CFR, Part 571.3, *Definitions*, and FMVSS No. 222, *School Bus Passenger Seating and Crash Protection*.
- 2. All seats shall have a minimum cushion depth of 15 inches and a seat back height of 24 inches above the seating reference point and must comply with all other requirements of FMVSS No. 222.
- 3. All restraining barriers and passenger seats shall be constructed with materials that enable them to meet the criteria of the *School Bus Seat Upholstery Fire Block Test*.
- 4. Each seat leg shall be secured to the floor by bolts, washers and nuts in order to meet the performance requirements of FMVSS No. 222.. Flange-head nuts may be used in lieu of nuts and washers. All seat frames attached to the seat rail shall be fastened with two or more bolts, washers and nuts or with flange-head nuts. Seats may be track-mounted in conformance with FMVSS No. 222.
- 5. If track seating is installed, the manufacturer shall supply minimum and maximum seat spacing dimensions (applicable to the bus) which comply with FMVSS No. 222. This information shall be on a label permanently

affixed to the bus.

6. All school buses (including Type A) shall be equipped with restraining barriers which conform to FMVSS No. 222.
7. A flip-up seat may be installed at any side emergency door. If provided, the flip-up seat shall conform to FMVSS No. 222 and aisle clearance requirements of FMVSS No. 217, *Bus Emergency Exits and Window Retention and Release*. The flip-up seat shall be free of sharp projections on the underside of the seat bottom. The underside of the flip-up seat bottoms shall be padded or contoured to reduce the possibility of clothing being snagged. Flip-up seats shall be constructed to prevent passenger limbs from becoming entrapped between the seat back and the seat cushion when the seat is in the upright position. The seat cushion shall be designed to rise to a vertical position automatically when it is not occupied.
8. Lap belts shall not be installed on passenger seats in large school buses (over 10,000 pounds GVWR) except in conjunction with child safety restraint systems that comply with the requirements of FMVSS No. 213, *Child Restraint Systems*.

B. Pre-School Age Seating

Passenger seats designed to accommodate a child or infant carrier seat shall comply with FMVSS No. 225, *Child Restraint Anchorage Systems*. These seats shall be in compliance with NHTSA's "Guideline for the Safe Transportation of Pre-school Age Children in School Buses." (**Note:** See A.8, above.)

C. Driver Seat

1. The driver's seat supplied by the body manufacturer shall be a high back seat. The seat back shall be adjustable to 15 degrees minimum without requiring the use of tools. The seat shall be equipped with a head restraint to accommodate a 5th percentile female to a 95th percentile adult male as defined in FMVSS No. 208, *Occupant Crash Protection*.
2. Type A buses may utilize the standard driver's seat provided by the chassis manufacturer.

D. Driver Restraint System

A Type 2 lap/shoulder belt shall be provided for the driver. On buses where the driver's seat and upper anchorage for the shoulder belt are both attached to the body structure, a driver's seat with an integrated Type 2 lap/shoulder belt may be substituted. On buses where the driver's seat and upper anchorage for the shoulder belt are separately attached to both body and chassis structures (i.e., one attached to the chassis and the other attached to the body), a driver's seat with an integrated Type 2 lap/shoulder belt should be used.

The assembly shall be equipped with an emergency locking retractor for the continuous belt system. On all buses except Type A that are equipped with a standard chassis manufacturer's driver's seat, the lap portion of the belt system shall be guided or anchored to prevent the driver from sliding sideways under the belt system. The lap/shoulder belt shall be designed to allow for easy adjustment

in order to fit properly and to effectively protect drivers varying in size from 5th percentile adult female to 95th percentile adult male. The belt shall be of a high visibility contrasting color. In vehicles where there is no OEM option for high visibility driver seat belts, the vehicle shall be equipped with a high visibility contrasting color seat belt cover.

- E. Each bus shall be equipped with a durable webbing cutter having a full width handgrip and a protected, replaceable or non-corrodible blade. The required webbing cutter shall be mounted in a location accessible to the seated driver in an easily detachable manner.

SHOCK ABSORBERS

The bus shall be equipped with double-action shock absorbers compatible with the manufacturer's rated axle capacity at each wheel location.

SIDE SKIRTS

School bus body side skirts between the front and rear axles shall extend down to within two inches, plus or minus, of the horizontal line from the center of the front spindle to the center of the rear axle. The manufacturer may offer optional side skirt lengths that extend lower than this requirement. This measurement shall apply to a new unloaded school bus located on a flat, level surface.

STEERING GEAR

- A. The steering gear shall be approved by the chassis manufacturer and designed to ensure safe and accurate performance when the vehicle is operated with maximum load and at maximum speed.
- B. If external adjustments are required, the steering mechanism shall be accessible to make adjustments.
- C. Changes shall not be made to the steering apparatus which are not approved by the chassis manufacturer.
- D. There shall be a clearance of at least two inches between the steering wheel and cowl, instrument panel, windshield or any other surface.
- E. Power steering is required and shall be of the integral type with integral valves.
- F. The steering system shall be designed to provide a means for lubrication of all wear-points that are not permanently lubricated.
- G. The steering column shall be telescoping or tilting or both to accommodate a wide range of drivers.

STEPS

- A. The first step at the entrance door shall be not less than 10 inches and not more than 14 inches from the ground when measured from the top surface of the step to the ground, based on standard chassis specifications. **Exception:** On Type D vehicles, the first step at the entrance door shall be 12 inches to 16 inches from the ground. An auxiliary step may be provided to compensate for the increase in ground-to-first-step clearance. The auxiliary step is not required to be enclosed.
- B. Step risers shall not exceed a height of 10 inches. **Exception:** When plywood is used on a steel floor or step, the riser height may be increased by the thickness of

the plywood.

- C. Steps shall be enclosed to prevent accumulation of ice and snow.
- D. Steps shall not protrude beyond the side body line.

STEP TREADS

- A. All steps, including the floor line platform area, shall be covered with an elastomer floor covering having a minimum overall thickness of 0.187 inch.
- B. The step covering shall be permanently bonded to a durable backing material that is resistant to corrosion.
- C. Steps, including the floor line platform area, shall have a 1½-inch nosing that contrasts in color by at least 70 percent measured in accordance with the contrasting color specification in 36 CFR, Part 1192, ADA, *Accessibility Guidelines for Transportation Vehicles*.
- D. Step treads shall have the following characteristics:
 - 1. Abrasion resistance: Step tread material weight loss shall not exceed 0.40 percent, as tested under ASTM D-4060, *Standard Test Method for Abrasion Resistance of Organic Coatings by the Taber Abraser*, (CS-17 Wheel, 1000 gram, 1000 cycle).
 - 2. Weathering resistance: Step treads shall not break, crack, or check after ozone exposure (seven days at 50 phm at 40 degrees C) and Weatherometer exposure (ASTM D-750, *Standard Test Method for Rubber Deterioration in Carbon-Arc Weathering Apparatus*, seven days).
 - 3. Flame resistance: Step treads shall have a calculated burn rate of .01 mm per minute or less using the test methods, procedures and formulas listed in FMVSS No. 302, *Flammability of Interior Materials*.
 - 4. A spray on application type material may be used in lieu of item that meets the requirements of items B. through D. The material shall be applied not only to the interior surfaces of the service door step treads but to the exterior as well if not covered by undercoating.

STIRRUP STEPS

If the windshield and lamps are not easily accessible from the ground, there may be at least one folding stirrup step or recessed foothold installed on each side of the front of the body for easy accessibility for cleaning. There also may be a grab handle installed in conjunction with the step. Steps are permitted in or on the front bumper in lieu of the stirrup steps if the windshield and lamps are easily accessible for cleaning from that position.

STOP SIGNAL ARM

The stop signal arm(s) shall comply with the requirements of FMVSS No. 131, *School Bus Pedestrian Safety Devices*. Stop signal arm lights shall use LEDs. MFSABs are exempt from these requirements.

STORAGE COMPARTMENT (OPTIONAL)

A storage container for tools, tire chains, and other equipment may be located either

inside or outside the passenger compartment. If inside, it shall be fastened to the floor and have a cover with a positive fastening device.

SUN SHIELD

- A. On Types B, C and D vehicles, an interior adjustable transparent sun shield, with a finished edge and dimensions not less than 6x30 inches, shall be installed in a position convenient for use by the driver.
- B. On Type A buses, the sun shield (visor) shall be installed by the chassis manufacturer.

SUSPENSION SYSTEMS

- A. The capacity of springs or suspension assemblies shall be commensurate with the chassis manufacturer's GVWR.
- B. Rear leaf springs shall be of a progressive rate or multi-stage design. Front leaf springs shall have a stationary eye at one end and shall be protected by a wrapped leaf in addition to the main leaf.

THROTTLE

The force required to operate the throttle shall not exceed 16 pounds throughout the full range of accelerator pedal travel.

TIRES AND RIMS

- A. Rims and tires of the proper size and load rating commensurate with the chassis manufacturer's GVWR shall be provided. The use of multi-piece rims and/or tube-type tires shall not be permitted on any school bus ordered after December 31, 1995.
- B. Dual rear tires shall be provided on Type A-2, Type B, Type C and Type D school buses.
- C. All tires on a vehicle shall be of the same size, and the load range of the tires shall meet or exceed the GVWR, as required by FMVSS No. 120, *Tire Selection and Rims for Vehicles other than Passenger Car*.
- D. If the vehicle is equipped with a spare tire and rim assembly, it shall be the same size as those mounted on the vehicle.
- E. If a tire carrier is required, it shall be suitably mounted in an accessible location outside of the passenger compartment.

TOWING ATTACHMENT POINTS

Two (2) front and two (2) rear towing devices (i.e., tow hooks, tow eyes, or other designated towing attachment points) shall be furnished to assist in the retrieval of buses that are stuck and/or for towing buses when a wrecker with a "wheel lift" or an "axle lift" is not available or cannot be applied to the towed vehicle.

- A. Towing devices shall be attached to the chassis frame either by the chassis manufacturer or in accordance with the chassis manufacturer's specifications.
- B. Each towing device shall have a strength rating of 13,500 pounds each for a combined rating of 27,000 pounds with the force applied in the rearward direction, parallel to the ground, and parallel to the longitudinal axis of the chassis frame rail. For pulling and lifting purposes, tow hooks are meant to be used

simultaneously. For pulling, angularity applied to the tow hooks will decrease the capacities of the tow hooks.

C. The towing devices shall be mounted such that they do not project forward of the front bumper or rearward of the rear bumper.

Note: Type A buses are exempt from the requirement for front tow hooks or eyes due to built-in crush zones.

TRACTION ASSISTING DEVICES (OPTIONAL)

A. Where required or used, sanders shall:

1. Be hopper cartridge-valve type;
2. Have a metal hopper with all interior surfaces treated to prevent condensation of moisture;
3. Have at least 100 pounds (grit) capacity;
4. Have a cover that screws in place on the filler opening of the hopper, thereby sealing the unit airtight;
5. Have discharge tubes extending under the fender wheelhousing to the front of each rear wheel;
6. Have non-clogging discharge tubes with slush-proof, non-freezing rubber nozzles;
7. Be operated by an electric switch with a pilot lamp mounted on the instrument panel located so as to be exclusively controlled by the driver;
8. Be equipped with a gauge to indicate that the hopper has reached the one quarter level (and needs to be refilled); and
9. Be designed to prevent freezing of all activation components and moving parts.

B. Automatic traction chains may be installed.

TRANSMISSION

A. Automatic transmissions shall have no fewer than three forward speeds and one reverse speed. Mechanical shift selectors shall provide a detent between each gear position when the gear selector quadrant and shift selector are not steering column mounted.

B. Automatic transmissions shall have a transmission shifter interlock controlled by the application of the service brake to prohibit accidental engagement of the transmission.

C. Transmissions will be automatic.

TRASH CONTAINER AND HOLDING DEVICE (OPTIONAL)

When requested or used, the trash container shall be secured by a holding device that is designed to prevent movement and to allow easy removal and replacement. It shall be installed in an accessible location in the driver's compartment, not obstructing passenger access to the entrance door.

TURNING RADIUS

A. A chassis with a wheelbase of 264 inches or less shall have a right and left turning radius of not more than 42½ feet, curb-to-curb measurement.

- B. A chassis with a wheelbase of 265 inches or more shall have a right and left turning radius of not more than 44½ feet, curb-to-curb measurement.

UNDERCOATING

- A. The entire underside of the bus body, including floor sections, cross member and below floor-line side panels, shall be coated with rust-proofing material for which the material manufacturer has issued a notarized certification to the bus body manufacturer that materials meet or exceed all performance requirements of SAE J1959.
- B. The undercoating material shall be applied with suitable airless or conventional spray equipment to the undercoating material manufacturer recommended film thickness and shall show no evidence of voids in the cured film.
- D. The undercoating material shall not cover any exhaust components of the chassis.

VENTILATION

- A. Auxiliary fans shall meet the following requirements:
 - 1. At least one Auxiliary Fan is required. Fan(s) shall be placed in a location for maximum effectiveness and so as not to obstruct the driver's vision to the mirrors or interfere with the safe operation of the vehicle.
 - 2. Fans shall have six-inch (nominal) diameter.
 - 3. Fan blades shall be enclosed in a protective cage. Each fan shall be controlled by a separate switch.
- B. The bus body shall be equipped with a suitably controlled ventilating system with capacity sufficient to maintain the proper quantity of air flow under operating conditions without having to open a window except in extremely warm weather.
- C. Static-type, non-closeable exhaust ventilation shall be installed in a low-pressure area of the roof.
- D. Roof hatches designed to provide ventilation in all types of exterior weather conditions may be provided.

WHEELHOUSING

- A. The wheelhousing opening shall allow for easy tire removal and service.
- B. Wheel housings shall be attached to the floor panels in a manner to prevent any dust, water or fumes from entering the body. Wheel housings shall be constructed of 16- gauge (or thicker) steel.
- C. The inside height of the wheel housings above the floor line shall not exceed 12 inches.
- D. The wheel housings shall provide clearance for installation and use of tire chains on single or dual (if so equipped) power-driving wheels.
- E. No part of a raised wheelhousing shall extend into the emergency door opening.

WINDOWS

- A. Other than emergency exits designated to comply with FMVSS No. 217, *Bus Emergency Exits and Window Retention and Release*, each side window shall provide an unobstructed opening of at least nine inches high (but not more than 13 inches high) and at least 22 inches wide, obtained by lowering the window. One

- window on each side of the bus may be less than 22 inches wide.
- B. Passenger compartment glass shall be tinted with approximate 28% light transmission.
 - C. Frost-free glazing may be installed in all doors or windows.
 - D. Windshields shall comply with federal, state and local regulations.

WINDSHIELD WASHERS

A windshield washer system shall be provided.

WINDSHIELD WIPERS

- A. A two-speed or variable speed windshield wiping system, with an intermittent feature, shall be provided and shall be operated by a single switch.
- B. The wipers shall meet the requirements of FMVSS No. 104, *Windshield Wiping and Washing Systems*.

Oklahoma Specifications for Specially Equipped School Buses

INTRODUCTION

Equipping buses to accommodate students with disabilities is dependent upon the needs of the passengers. While one bus may be fitted with a lift, another may have belts installed to secure child seats. Buses so equipped are not to be considered a separate class of school bus but simply a regular school bus that is equipped for special accommodations.

The specifications in this section are intended to supplement specifications in the BODY AND CHASSIS section. In general, specially equipped buses shall meet all the requirements of the preceding sections, plus those listed in this section. The field of special transportation is characterized by varied needs for individual cases and by rapidly emerging technologies for meeting individual student needs. A flexible, “common sense” approach to the adoption and enforcement of specifications for these vehicles, therefore, is prudent.

As defined by 49 Code of Federal Regulations (CFR) §571.3, “*Bus* means a motor vehicle with motive power, except a trailer, designed for carrying more than ten persons” (11 or more including the driver). This definition also embraces the more specific category, *school bus*. Vehicles with 10 or fewer occupant positions (including the driver) are not classified as buses. For this reason, the federal vehicle classification, *multipurpose passenger vehicle* (49 CFR § 571.3), or MPV, must be used by manufacturers for these vehicles in lieu of the classification *school bus*.

The definition of *designated seating position* in 49 CFR § 571.3 states that in the case of “vehicles sold or introduced into interstate commerce for purposes that include carrying students to and from school or related events” and which are “intended for securement of an occupied wheelchair during vehicle operations,” each wheelchair securement position shall be counted as four designated seating positions when determining the classification (whether *school bus* or *MPV*). This classification system does not preclude state or local agencies or these national specifications from requiring compliance of school bus-type MPVs with the more stringent

federal standards for school buses. The following specifications address modifications as they pertain to school buses that, with standard seating arrangements prior to modification, would accommodate eleven or more occupants including the driver. If by addition of a power lift, wheelchair positions or other modifications, the capacity is reduced such that vehicles become MPVs, the intent of these specifications is to require these vehicles to meet the same specifications they would have had to meet prior to such modifications, and such MPVs are included in all references to school buses and requirements for school buses which follow.

DEFINITION

A specially equipped school bus is any school bus that is designed, equipped and/or modified to accommodate students with special transportation needs.

GENERAL REQUIREMENTS

- A. Specially equipped school buses shall comply with the *National School Transportation Specifications and Procedures* and with the Federal Motor Vehicle Safety Standards (FMVSS) applicable to their Gross Vehicle Weight Rating (GVWR) category.
- B. Any school bus to be used for the transportation of children who utilize a wheelchair or other mobile positioning device, or who require life-support equipment that prohibits use of the regular service entrance, shall be equipped with a power lift.
- C. School bus bodies of this type shall meet all specifications as published in the Oklahoma Minimum Specifications for School Buses except for the modifications necessary for the installation of special equipment as listed herein.

AISLES

All school buses equipped with a power lift shall provide a minimum 30-inch pathway leading from any wheelchair position to at least one 30-inch wide emergency exit door. A wheelchair securement position shall never be located directly in front of (blocking) a power lift door location.

IDENTIFICATION

Specially equipped school buses shall display the International Symbol of Accessibility below the window line. Such emblems shall be white on blue or black background, shall not exceed 12 inches square in size, and shall be of a high-intensity retroreflective material meeting the requirements of Federal Highway Administration (FHWA) FP-85, *Standard Specifications for Construction of Roads and Bridges on Federal Highway Projects*.

PASSENGER CAPACITY RATING

In determining the passenger capacity of a school bus for purposes other than actual passenger load (e.g., vehicle classification or various billing/reimbursement models), any location in a school bus intended for securement of a wheelchair during vehicle operation shall be regarded as four designated seating positions, and each lift area shall count as four designated seating positions.

POWER LIFTS

- A. All specially equipped school buses shall include the installation of a power lift.
- B. The power lift shall be located on the right side of the bus body. Exception: The lift may be located on the left side of the bus if, and only if, the bus is used to deliver student only to the left side of one-way streets.
- C. Vehicle lift and installation
 - 1. General: Vehicle lifts and installations shall comply with the requirements set forth in FMVSS 403, *Platform Lift Systems for Motor Vehicles*, and FMVSS 404, *Platform Lift Installations in Motor Vehicles*.
 - 2. Design loads: The design load of the lift shall be at least 800 pounds. Working parts, such as cables, pulleys and shafts, which can be expected to wear, and upon which the lift depends for support of the load, shall have a safety factor of at least six, based on the ultimate strength of the material. Non-working parts, such as platform, frame and attachment hardware that would not be expected to wear, shall have a safety factor of at least three, based on the ultimate strength of the material.
 - 3. Lift capacity: The lifting mechanism and platform shall be capable of operating effectively with a wheelchair and occupant mass of at least 800 pounds.
 - 4. Controls: (See 49 CFR 571.403, S6.7, *Control systems*.)
 - 5. Emergency operations: (See 49 CFR 571.403, S6.9, *Backup operation*.)
 - 6. Power or equipment failures: (See 49 CFR 571.403, S6.2.2, *Maximum platform velocity*.)
 - 7. Platform barriers: (See 49 CFR 571.403, S6.4.7, *Wheelchair retention*.)
 - 8. Platform surface: (See 49 CFR 571.403, S6.4.2, S6.4.3, *Platform requirements*.) (See also “Wheelchair or Mobility Aid Envelope” figure at the end of this subsection.)
 - 9. Platform gaps and entrance ramps: (See 49 CFR 571.403, S6.4.4, *Gaps, transitions and openings*.)
 - 10. Platform deflection: (See 49 CFR 571.403, S6.4.5, *Platform deflection*.)
 - 11. Platform movement: (See 49 CFR 571.403, S6.2.3, *Maximum platform acceleration*.)
 - 12. Boarding direction: The lift shall permit both inboard and outboard facing of wheelchair and mobility aid users.
 - 13. Handrails: (See 49 CFR 571.403, S6.4.9, *Handrails*.)
 - 14. Circuit breaker: A resettable circuit breaker shall be installed between the source and the lift motor if electrical power is used. It shall be located as close to the power source as possible but not within the passenger/driver compartment.
 - 15. Excessive pressure: (See 49 CFR 571.403, S6.8, *Jacking prevention*.)
 - 16. Documentation: The following information shall be provided with each vehicle equipped with a lift:
 - a. A phone number where information can be obtained about installation, repair and parts. (Detailed written instructions and a parts list shall be available upon request.)

- b. Detailed instructions regarding use of the lift shall be readily visible when the lift door is open, including a diagram showing the proper placement and positioning of wheelchair/mobility aids on the lift.
- c. Training materials: The lift manufacturer shall make training materials available to ensure the proper use and maintenance of the lift. These may include instructional videos, classroom curriculum, system test results or other related materials.
- d. Identification and certification: Each lift shall be permanently and legibly marked or shall incorporate a non-removable label or tag that states it conforms to all applicable requirements of the current National School Transportation Specifications and Procedures. In addition and upon request of the original titled purchaser, the lift manufacturer or an authorized representative shall provide a notarized Certificate of Conformance, either original or photocopied, which states that the lift system meets all the applicable requirements of the current National School Transportation Specifications and Procedures.

Note: graphic of wheelchair or mobility aid envelope (Figure 1).

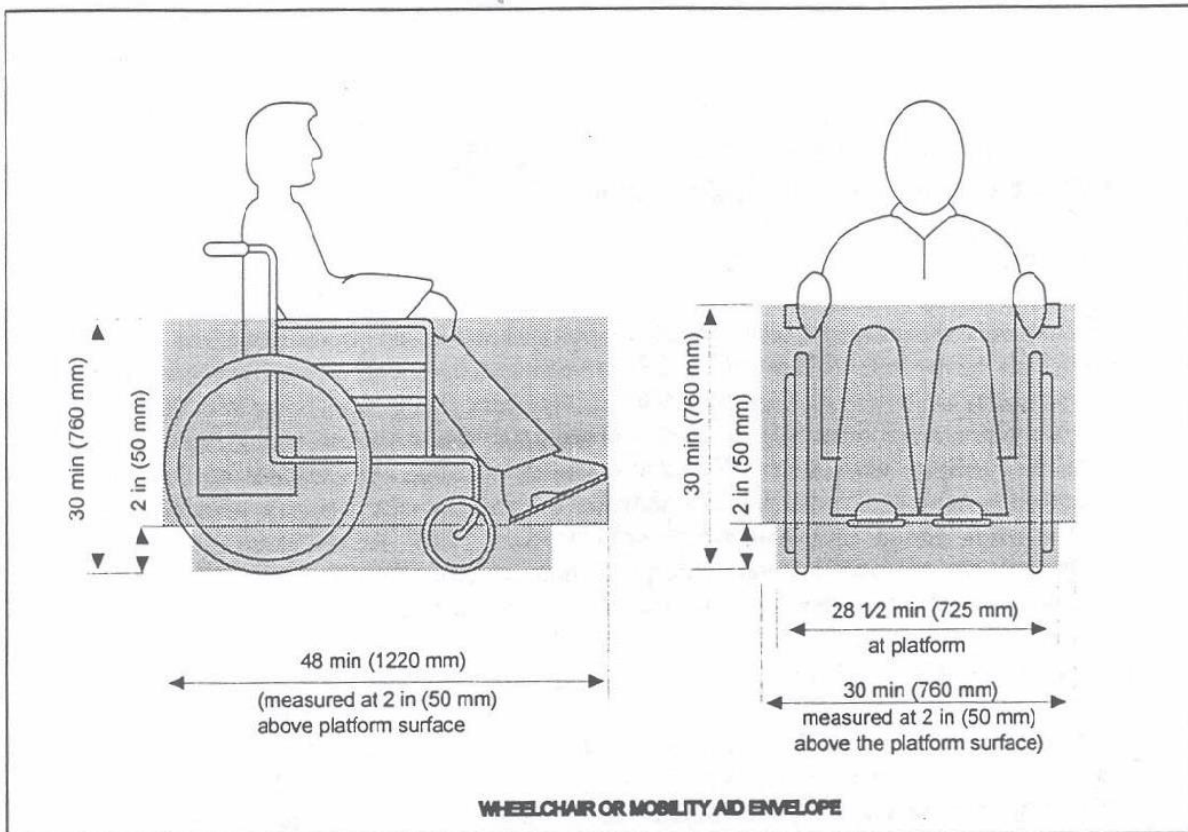

REGULAR SERVICE ENTRANCE

- A. On power lift-equipped vehicles, steps shall be the full width of the step well, excluding the thickness of the doors in the open position.
- B. In addition to the handrail required in the BUS BODY AND CHASSIS section, an additional handrail shall be provided on all lift buses. This handrail shall be located on the opposite side of the entrance door from the handrail required in the BUS BODY AND CHASSIS section and shall meet the same requirements for handrails.

RESTRAINING DEVICES

- A. On power lift-equipped school buses with a GVWR of 10,000 pounds or more, seat frames may be equipped with attachment points to which belt assemblies can be attached for use with child safety restraint systems (CSRSs) that comply with FMVSS No. 213, *Child Restraint Systems*. Any belt assembly anchorage shall comply with FMVSS No. 210, *Seat Belt Assembly Anchorages*.
- B. Alternatively, a child restraint anchorage system that complies with FMVSS No. 225, *Child Restraint Anchorage Systems*, may be installed.
- C. Seat belt assemblies, if installed, shall conform to FMVSS No. 209, *Seat Belt Assemblies*.
- D. Child safety restraint systems, which are used to facilitate the transportation of children who in other modes of transportation would be required to use a child, infant or booster seat, shall conform to FMVSS No. 213.

SEATING ARRANGEMENTS

Flexibility in seat spacing to accommodate special devices shall be permitted to meet passenger requirements. All seating shall meet the requirements of FMVSS No. 222, *School Bus Passenger Seating and Crash Protection*.

SECUREMENT AND RESTRAINT SYSTEM FOR WHEELCHAIRS AND WHEELCHAIR-SEATED OCCUPANTS

For purposes of understanding the various aspects and components of this section, the terms *securement* and *tie down* and the phrases *securement system* or *tie down system* are used exclusively in reference to the devices that anchor the wheelchair to the vehicle. The term *restraint* and the phrase *restraint system* are used exclusively in reference to the equipment that is intended to limit the movement of the wheelchair occupant in a crash or sudden maneuver. The term *wheelchair tie down and occupant restraint system (WTORS)* is used to refer to the total system that secures the wheelchair and restrains the wheelchair occupant.

A. **WTORS**—general requirements:

1. A wheelchair tie down and occupant restraint system installed in specially equipped school buses shall be designed, installed, and operated for use with forward-facing wheelchair-seated passengers and shall comply with all applicable requirements of FMVSS 222, *School Bus Passenger Seating and Crash Protection*, and SAE J2249, *Wheelchair Tie down and Occupant Restraint Systems for Use in Motor Vehicles*.¹ A wheelchair tie down and occupant restraint system designed to comply with all applicable requirements of WC-18, *Wheelchair Tie down and*

Occupant Restraint Systems for Use in Motor Vehicles may be installed in specially equipped school buses. Consultation between the user and the manufacturer is recommended to ensure that appropriate restraint systems are provided.

2. The WTORS, including the anchorage track, floor plates, pockets or other anchorages, shall be provided by the same manufacturer or shall be certified to be compatible by manufacturers of all equipment/systems used.
 3. Wheelchair securement positions shall be located such that wheelchairs and their occupants do not block access to the lift door.
 4. A device for storage of the WTORS shall be provided. When the system is not in use, the storage device shall allow for clean storage of the system, shall keep the system securely contained within the passenger compartment, shall provide reasonable protection from vandalism, and shall enable the system to be readily accessed for use.
 5. The WTORS, including the storage device, shall meet the flammability standards established in FMVSS No. 302, *Flammability of Interior Materials*.
 6. The following information shall be provided with each vehicle equipped with a securement and restraint system:
 - a. A phone number where information can be obtained about installation, repair and parts. (Detailed written instructions and a parts list shall be available upon request.)
 - b. Detailed instructions regarding use, including a diagram showing the proper placement of the wheelchair/mobility aids and positioning of securement devices and occupant restraints, including correct belt angles.
 7. The WTORS manufacturer shall make training materials available to ensure the proper use and maintenance of the WTORS. These may include instructional videos, classroom curriculum, system test results or other related materials.
- B. Wheelchair Securement/Tiedown: (See 49 CFR 571.222, S5.4.1, S5.4.2.) Each wheelchair position in a specially equipped school bus shall have a minimum clear floor area of 30 inches laterally by 48 inches longitudinally. Additional floor area may be required for some wheelchairs. Consultation between the user and the manufacturer is recommended to ensure that adequate area is provided.
- C. Occupant restraint system: (See 49 CFR 571.222, S5.4.3, S5.4.4.) If the upper torso belt anchorage is higher than 44", measured from the vehicle floor, an adjustment device, as part of the occupant restraint system shall be supplied.

SPECIAL LIGHT

Doorways in which lifts are installed shall be equipped with a special light that provides a minimum of two foot-candles of illumination measured on the floor of the bus immediately adjacent to the lift during lift operation.

SPECIAL SERVICE ENTRANCE

A. Power lift-equipped bodies shall have a special service entrance to accommodate the

power lift. **Exception:** A special service entrance shall not be required if the lift is designed to operate within the regular service entrance, is capable of stowing such that the regular service entrance is not blocked in any way and a person entering or exiting the bus is not impeded in any way.

- B. The special service entrance and door shall be located on the right side of the bus and shall be designed so as not to obstruct the regular service entrance. **Exception:** A special service entrance and door may be located on the left side of the bus only if the bus is used only to deliver students to the left side of one-way streets and its use is limited to that function.
- C. The opening may extend below the floor through the bottom of the body skirt. If such an opening is used, reinforcements shall be installed at the front and rear of the floor opening to support the floor and give the same strength as other floor openings.
- D. A drip molding shall be installed above the special service entrance to effectively divert water from the entrance.
- E. Door posts and headers at the special service entrance shall be reinforced sufficiently to provide support and strength equivalent to the areas of the side of the bus not used for the special service entrance.

SPECIAL SERVICE ENTRANCE DOORS

- A. A single door or double doors may be used for the special service entrance.
- B. A single door shall be hinged to the forward side of the entrance unless this would obstruct the regular service entrance. If the door is hinged to the rearward side of the doorway, the door shall utilize a safety mechanism that will prevent the door from swinging open should the primary door latch fail. If double doors are used, the system shall be designed to prevent the door(s) from being blown open by the aerodynamic forces created by the forward motion of the bus and shall incorporate a safety mechanism to provide secondary protection should the primary latching mechanism(s) fail.
- C. All doors shall have positive fastening devices to hold doors in the “open” position when the special service entrance is in use.
- D. All doors shall be weather sealed.
- E. When manually operated dual doors are provided, the rear door shall have at least a one-point fastening device to the header. The forward-mounted door shall have at least three one-point fastening devices. One shall be to the header, one to the floor line of the body, and the other shall be into the rear door. The door and hinge mechanism shall have strength that is greater than, or equivalent to, the strength of the emergency exit door.
- F. Door materials, panels and structural components shall have strength equivalent to the conventional service and emergency doors. Color, rub rail extensions, lettering, and other exterior features shall match adjacent sections of the body.
- G. Each door shall have windows set in a waterproof manner that are visually similar in size and location to adjacent non-door windows. Glazing shall be of the same type and tinting (if applicable) as standard fixed glass in other body locations.
- H. Door(s) shall be equipped with a device that will actuate an audible or visible signal

located in the driver's compartment when the door(s) is not securely closed and the ignition is in the "on" position.

- I. A switch shall be installed so that the lift mechanism will not operate when the lift platform door(s) is closed.
- J. Special service entrance doors shall be equipped with padding at the top edge of the door opening. The padding shall be at least three inches wide and one inch thick and shall extend the full width of the door opening.

SUPPORT EQUIPMENT AND ACCESSORIES

- A. In addition to the webbing cutter required in the BUS BODY AND CHASSIS section, each specially equipped school bus that is set up to accommodate wheelchairs or other assistive or restraint devices with webbing attached shall contain an additional webbing cutter properly secured in a location to be determined by the purchaser. The webbing cutter shall meet the requirements listed in the BUS BODY AND CHASSIS section, seats and Restraining Barriers, paragraph E.
- B. Each special equipped school bus that is set up to accommodate wheelchairs or other assistive restraint devices should be equipped with an emergency evacuation device certified and tested to withstand at least a 300 pound load when used as an emergency stretcher or drag. This evacuation device shall be properly secured to the bus in a location to be determined by the purchaser.
- C. Special equipment or supplies that are used in the bus for mobility assistance, health Support, or safety purposes shall meet local, federal and engineering standards that may apply, including requirements for proper identification. Equipment that may be used for these purposes includes, but is not limited to:
 - 1. Wheelchairs and other mobile seating devices. (See subsection on Securement and Restraint System for Wheelchairs and Wheelchair-seated Occupants.)
 - 2. Crutches, walkers, canes and other ambulating devices to assist ambulation.
 - 3. Medical support equipment. This may include respiratory devices, such as oxygen bottles (which should be no larger than 38 cubic feet for compressed gas) or ventilators. Tanks and valves should be located and positioned to protect them from direct sunlight, bus heater vents, or other heat sources. Other equipment may include intravenous and fluid drainage apparatus.
- D. If installed, oxygen tank retention systems shall meet Ambulance Manufacturers Division (AMD) Standard 003 (Oxygen Tank Retention System) test procedures, REV. 10-98.

SUSPENSION

Type C/D special needs buses that are equipped with a wheelchair lift shall have an air-ride rear suspension system.

TECHNOLOGY AND EQUIPMENT, NEW

These specifications are intended to accommodate new technologies and equipment that will better facilitate the transportation of students with special needs. New technology and equipment is acceptable for use in specially equipped vehicles if:

- A. It does not compromise the effectiveness or integrity of any major safety system.
(Examples of safety systems include, but are not limited to, compartmentalization, the eight-lamp warning system, emergency exits and the approved color scheme.)
- B. It does not diminish the safety of the bus interior.
- C. It does not create additional risk to students who are boarding or exiting the bus or are in or near the school bus loading zone.
- D. It does not require undue additional activity and/or responsibility for the driver.
- E. It generally increases efficiency and/or safety of the bus, generally provides for a safer or more pleasant experience for the occupants and pedestrians in the vicinity of the bus, and generally assists the driver and makes his/her many tasks easier to perform.

APPENDIX for Oklahoma Minimum School Bus Specifications 2012 SCHOOL BUS BODY AND CHASSIS

National School Bus Yellow Standard

The color known as “National School Bus Yellow” (NSBY) is specified and described in the School Bus Manufacturers Technical Council publication SBMTC-008, National School Bus Yellow Color Standard.

Note: Information concerning the purchase of this standard may be obtained from the Executive Director of the National Association of State Directors of Pupil Transportation Services (NASDPTS) at 1-800-585-0340 or execdir@nasdpts.org.

Bus Body Heating System Test

1. Scope

This procedure, limited to liquid coolant systems, establishes uniform cold weather bus vehicle heating system test procedures for all vehicles designed to transport ten (10) or more passengers. Required test equipment, facilities and definitions are included. Defrosting and defogging procedures and requirements are established by SAE J381, *Windshield Defrosting Systems Test Procedure and Performance Requirements—Trucks, Buses, and Multipurpose Vehicles*, and SAE J382, *Windshield Defrosting Systems Performance Guidelines—Trucks, Buses, and Multi-Purpose Vehicles*, which are hereby included by reference.

1.1 Purpose

This procedure is designed to provide bus manufacturers with a cost-effective, standardized test method to provide relative approximations of cold weather interior temperatures.

2. Definitions

- 2.1 Heat Exchanger System** - Means will exist for providing heating and windshield defrosting and defogging capability in a bus. The system shall consist of an integral assembly or assemblies, having a core assembly or assemblies, blower(s), fan(s) and necessary duct systems and controls to provide heating, defrosting and defogging functions. If the bus body structure makes up some portion of the duct system, this structure or a simulation of this structure must be included as part of the system.
- 2.2 Heat Exchanger Core Assembly** - The core shall consist of a liquid-to-air heat transfer surface(s), liquid inlet and discharge tubes or pipes.
- 2.3 Heat Exchanger-Defroster Blower** - An air moving device(s) compatible with energies available on the bus body.
- 2.4 Coolant** - A 50-50 solution of commercially available glycol antifreeze and commercial purity water. Commercial purity water is defined as “that water obtained from a municipal water supply system.”
- 2.5 Heat Exchanger-Defroster Duct System** - Passages that conduct inlet and discharge air throughout the heater system. The discharge outlet louvers shall be included as part of the system.
- 2.6 Heater Test Vehicle** - The completed bus as designed by the manufacturer with or without a chassis, engine and driver train, including the defined heat exchanger system. If the vehicle is without a chassis, it shall be placed on the test site in such a way that the finished floor of the body is at a height, from the test site floor, equal to its installed height when on a chassis, and all holes and other openings normally filled when installed on a chassis will be plugged.
- 2.7 Heat Transfer** - The transfer of heat from liquid to air is directly proportional to the difference between the temperatures of the liquid and air entering the transfer system, for a given rate of liquid and air flow measured in pounds per minute, and that heat removed from liquid is equal to heat given to air.

3. Equipment

- 3.1 Test Site** - A suitable location capable of maintaining an average ambient temperature not to exceed 25°F (-3.9°C) for the duration of the test period. The maximum air velocity across the vehicle shall be 5 mph (8 kph).
- 3.2 Coolant Supply** - A closed loop system, independent of any engine/drive train system, capable of delivering a 50-50 (by volume) solution of antifreeze-water, as defined in 2.4, at $150^{\circ}\pm 5^{\circ}$ ($65.5^{\circ}\pm 1.7^{\circ}$ C) above the test site ambient temperature, and 50 lbs (22.7 kg) per minute flow. The coolant supply device shall be equipped with an outlet diverter valve to circulate coolant within the device during its warm-up period. The valve will then permit switching the coolant supply to the bus heat exchanger system at the start of the test.
- 3.3 Power Equipment Supply** - A source capable of providing the required test voltage and current for the heater system.
- 3.4 Heat Exchange Units** - The heat exchangers used shall be labeled as specified by the School Bus Manufacturers Technical Council Standard No. 001, *Procedure for Testing and Rating Automotive Bus Hot Water and Heating and Ventilating*

Equipment (Revised 4/94). The test rating of each unit, and quantity used, shall be recorded.

4. Instrumentation

4.1 Air Temperature

4.1.1 Interior - Recommended air temperature measuring instrumentation are thermocouples or resistance temperature detectors (RTDs). Thermometers are not recommended because of their slow response to rapid temperature changes. Measuring instrumentation shall be placed on alternate seat rows beginning 39±5 inches (99±13 cm) from the rear of the body, at 36±2 inches (91±5 cm) from the finished floor of the body, and on the longitudinal centerline of the body.

4.1.2 Ambient - A set of four electrically averaged temperature measuring devices shall be placed 18±5 inches (46±13 cm) from the nearest body surface, 96±5 inches (243±13 cm) above the floor of test site. One measuring device shall be placed at each of the following locations:

- (1) Midline of body forward of windshield;
- (2) Midline of body aft of the rear surface; and
- (3) Midway between the axles on the right and left sides of the body.

4.1.3 Driver - Measuring devices shall be placed at appropriate locations to measure ankle, knee, and breath level temperatures with the driver's seat in rearmost, lowest and body center-most position.

- (1) Ankle Level - Place a minimum of four electrically averaged temperature measuring devices at the corners of a 10 x 10 inches (25x25cm) square area, the rearmost edge of which begins 8 inches (20 cm) forward of the front edge of, and centered on, the seat cushion. The devices shall be located 3±0.5 inches (7.5±1.3 cm) above floor surface.
- (2) Knee Level - Place a minimum of one measuring device at the height of the front top edge of the seat cushion and on the centerline of the seat. This measurement shall be 4±1 inches (10±2.5 cm) forward of the extreme front edge of the seat cushion and parallel to the floor.
- (3) Breath Level - Place a minimum of one measuring device 42±2 inches (107±5 cm) above the floor and 10±2 inches (25±5 cm) forward of the seat back. The forward dimension shall be measured from the upper edge of the seat back and parallel to the floor.

4.1.4 (Optional) Heat Exchanger Inlet and Outlet Temperature - A minimum of four electrically averaged temperature measuring devices shall be used to measure the inlet air temperature of each heat exchange unit. Additionally, a minimum of four electronically averaged temperature measuring devices shall be used to measure the outlet air temperature of each heat exchange unit. These sensors shall be placed no closer than 2.0 inches (5.1 cm) from the face of any heater core, to prevent any incidence of radiant heat transfer. Outlet sensors shall be distributed throughout the outlet air stream(s) 1.0±0.25 inches (2.5±0.6 cm) from the outlet aperture(s) of the unit heater.

4.1.5 (Optional) Defrost Air Temperature - The temperature of the defrost air shall be measured at a point in the defroster outlet(s) that is in the main air flow and which is at least 1.0 inch (2.54 cm) below (upstream of) the plane of the defroster outlet opening. At least one temperature measurement shall be made in each outlet unit. The interior surface temperature(s) of the windshield shall be measured at a point located on the vertical and horizontal centerline(s) of the

windshield.

4.1.6 (Optional) Entrance Area Temperature - The temperature of the vehicle entrance area shall be measured by two sets of three each electrically averaged temperature measuring devices. One set of three devices shall be placed 1.0 inch (2.54 cm) above the lowest tread of the entrance step, equally spaced on the longitudinal centerline of the tread. The second set of devices shall be placed on the next horizontal surface above the lowest entrance step, 4.0 inches (10.2 cm) from the outboard edge of that surface, spaced identically to the first set of sensors, and placed parallel with the outboard edge of the surface being measured.

- 4.2 Coolant Temperature** - The temperature entering and leaving the heat exchanger/defroster system shall be measured as close to the entrance and exit points of the bus body as possible with an immersion thermocouple or RTD device which can be read within $\pm 0.5^{\circ}\text{F}$ ($\pm 0.3^{\circ}\text{C}$).
- 4.3 Coolant Flow** - The quantity of coolant flowing shall be measured by means of a calibrated flow meter or weighing tank to an accuracy of at least 2% of setpoint.
- 4.4 Coolant Pressure** - The coolant differential pressure shall be measured by suitable connection as close as possible to the inlet and outlet of the heat exchanger/defrosting system. Pressure may be read as inlet and outlet pressure and the differential calculated, or read directly as PSID. Pressure readings shall be made with the use of gauges, manometers or transducers capable of reading within ± 0.1 psi (689.5 Pa), accurate to $\pm 0.5\%$ of full scale.
- 4.5 Additional Instrumentation** - Additional instrumentation required for vehicle heat exchanger system testing is a voltmeter and a shunt-type ammeter to read the voltage and current of the complete system. The ammeter and voltmeter shall be capable of an accuracy of $\pm 1\%$ of the reading.

5. Test Procedures - Install the heater test vehicle on the test site. Testing shall be conducted in such a way as to prevent the effects of solar heating. At an outdoor test site, testing shall commence and data shall be recorded during the hours following sunset and prior to sunrise, regardless of cloud cover or facility roof. Instrumentation is required to obtain the following readings:

- (a) Vehicle interior (4.1.1);
- (b) Inlet coolant temperature, at entrance to the bus body (4.2);
- (c) Discharge coolant temperature, at exit from the bus body (4.2);
- (d) Voltage and current at main bus bar connection of driver's control panel;
- (e) Ambient temperature (4.1.2);
- (f) Rate of coolant flow (4.3);
- (g) Coolant flow pressure (4.4);
- (h) Elapsed time (stop watch);
- (i) Driver's station temperatures (4.1.3);
- (j) (Optional) Heat Exchanger Inlet and Outlet Temperatures (4.1.4);
- (k) (Optional) Defrost Air Temperature (4.1.5); and
- (l) (Optional) Entrance Area Temperature (4.1.6).

Soak the test vehicle, with doors open, for the length of time necessary to stabilize the interior temperature for a 30-minute period as recorded by the vehicle interior temperature measuring devices, and the coolant temperature as measured by the inlet and outlet coolant temperature measuring devices, at the test site temperature, $\pm 5^{\circ}\text{F}$ ($\pm 2.5^{\circ}\text{C}$), not to exceed 25°F (-3.9°C). Warm up the coolant device to the test temperature immediately prior to the start of the test. Use the coolant supply outlet diverter valve to prevent heated coolant from entering the bus heating system prior to the start of the test. At this time, set the heater controls and all fan controls at maximum, and close all doors. A maximum of two windows may be left open a total of 1.0 inch (2.5 cm) each. A

maximum of two occupants may be in the body during the test period. Record all instrumentation readings at five-minute intervals for a period of 1 hour. Recording time shall begin with the initial introduction of heated coolant from the independent coolant supply. The electrical system shall be operated at a maximum of 115% of nominal system voltage ± 0.2 volts, for example: 13.8 VDC ± 0.2 volts for a 12 volt (DC) system, and the heat exchanger system shall be wired with the normal vehicle wiring.

Optional: Additional flow rates and/or coolant temperatures may also be used to generate supplementary data. Procedure shall be repeated (see 5. Test Procedure) for each additional flow rate and/or coolant temperature.

6. Computations

6.1 Chart and Computations - Customary Units - Data shall be recorded on Chart 6.1, or equivalent. Temperature data shall be recorded at the actual temperatures occurring at the time of testing. Air temperature data shall then be adjusted to a 0°F base prior to the construction of graphs. This data reduction shall be directly proportional to the difference between the actual ambient temperature, at the time of test, and 0°F (i.e., actual ambient of 18°F shall result in a reduction of all air temperatures by 18°F and actual ambient temperature of -8°F shall result in an increase of all air temperatures by 8°F). Temperature data shall be presented in graph form as well as tabular form. One graph shall be constructed for the body interior air temperatures (4.1.1) wherein the recording intervals shall be the X-axis and the °F the Y-axis. A separate graph shall be constructed for the driver's temperatures (4.1.3) using the same units for the axes. Optional temperature data (4.1.4, 4.1.5, 4.1.6) may be similarly graphed separate from the interior data.

6.1.1 Optional Computations BTU/Hr. Coolant

Heat Transfer: $Q_w = C_p W_w (T_{in} - T_{out}) \times 60$ where:

1. W_w = Flow of Coolant (lb/min) — *measured to ± 2 percent*
2. T_{in} = Temperature of Coolant into System (°F) — *measured quantity*
3. T_{out} = Temperature of Coolant out of System (°F) — *measured quantity*
4. Q_w = Heat removed From Coolant (Btu/hr) — *calculated quantity*
5. C_p = Specific Heat of Coolant = 0.8515 (BTU/lb/°F) — *given quantity*

6.2 Chart and Computations - Metric Units - Data shall be recorded on Chart 6.2, or equivalent. Temperature data shall be recorded at the actual temperatures occurring at the time of testing. Air temperature data shall then be adjusted to a -18°C base prior to the construction of graphs. This data reduction shall be directly proportional to the difference between the actual ambient temperature, at the time of test, and -18°C (i.e., actual ambient of -7.8°C shall result in a reduction of all air temperatures by 10.2°C and actual ambient temperature of -22.2°C shall result in an increase of all air temperatures by 4.2°C). Temperature data shall be presented in graph form as well as tabular form. One graph shall be constructed for the body interior air temperatures (4.1.1) wherein the recording intervals shall be the X-axis and °C the Y-axis. A separate graph shall be constructed for the driver's temperatures (4.1.3) using the same units for the axes. Optional temperature data (4.1.4, 4.1.5, 4.1.6) may be similarly graphed separate from the interior data.

6.2.1 Optional Computations BTU/Hr – Coolant

Heat Transfer: $Q_w = C_p W_w (T_{in} - T_{out}) \times 60$ where:

1. W_w = Flow of Coolant (kg/min) — *measured to ± 2 percent*
2. T_{in} = Temperature of Coolant into System ($^{\circ}\text{C}$) — *measured quantity*
3. T_{out} = Temperature of Coolant out of System ($^{\circ}\text{C}$) — *measured quantity*
4. Q_w = Heat removed From Coolant (Joules/hr) — *calculated quantity*
5. C_p = Specific Heat of Coolant = 3559 (joule/kg/ $^{\circ}\text{C}$) — *given quantity*

This Area Intentionally Blank

Chart 6.1

Description of Unit

Purpose of Test

	Date										Location										Observers															
	5	10	15	20	25	30	35	40	45	50	55	60	5	10	15	20	25	30	35	40	45	50	55	60	5	10	15	20	25	30	35	40	45	50	55	60
Readings/Calculations Water																																				
Flow-lb/min																																				
Flow Pressure-PSID																																				
T-in °F																																				
T-out °F																																				
Air Temperature																																				
T1 rear- °F																																				
T2- °F																																				
T3- °F																																				
T4- °F																																				
T5- °F																																				
T6-front- °F																																				
T7-ambient- °F																																				
T8-Driver Ankle- °F																																				
T9-Driver Knee- °F																																				
T10-Driver Breath-°F																																				
Electrical System																																				
Volts																																				
Amps																																				

UTATIONAL CHART 6.1 (Fahrenheit)

COMP

Chart 6.1-Optional Measurements

Readings/Calculations	0	5	10	15	20	25	30	35	40	45	50	55	60
T11-Windshield CL Left- °F													
T12-Windshield CL Right- °F													
T13-Defrost Outlet Left- °F													
T14-Defrost Outlet Right °F													
T15-Heater-Inlet °F													
T15-Heater-Outlet °F													
T16-Heater-Inlet °F													
T16-Heater-Outlet °F													
T17-Heater-Inlet °F													
T17-Heater-Outlet °F													
T18-Heater-Inlet °F													
T18-Heater-Outlet °F													
T19-1st Entrance Step													
T20-2nd Entrance Step													
Heat Transfer-BTU/Hr-coolant													

COMPUT

OPTIONAL CHART 6.1-Optional (Fahrenheit)

Chart 6.2

Description of Unit

Purpose of Test

Date	Location	Observers																						
		5	10	15	20	25	30	35	40	45	50	55	60											
Readings/Calculations																								
Water																								
Flow-kg/min																								
Flow Pressure-PaD																								
T-in °C																								
T-out °C																								
Air Temperature																								
T1 rear- °C																								
T2- °C																								
T3- °C																								
T4- °C																								
T5- °C																								
T6-front- °C																								
T7-ambient- °C																								
T8-Driver Ankle- °C																								
T9-Driver Knee- °C																								
T10-Driver Breath- °C																								
Electrical System																								
Volts																								
Ampu																								

COMPUTATIONAL CHART 6.2 (Celsius)

Chart 6.2-Optional Measurements

Readings/Calculations	0	5	10	15	20	25	30	35	40	45	50	55	60
T11-Windshield CL Left- °C													
T12-Windshield CL Right- °C													
T13-Defrost Outlet Left- °C													
T14-Defrost Outlet Right °C													
T15-Heater-Inlet °C													
T15-Heater-Outlet °C													
T16-Heater-Inlet °C													
T16-Heater-Outlet °C													
T17-Heater-Inlet °C													
T17-Heater-Outlet °C													
T18-Heater-Inlet °C													
T18-Heater-Outlet °C													
T19-1st Entrance Step													
T20-2nd Entrance Step													
Heat Transfer-I/Hr-coolant													

COMPUTATIONAL CHART 6.2 - Optional (Celsius)

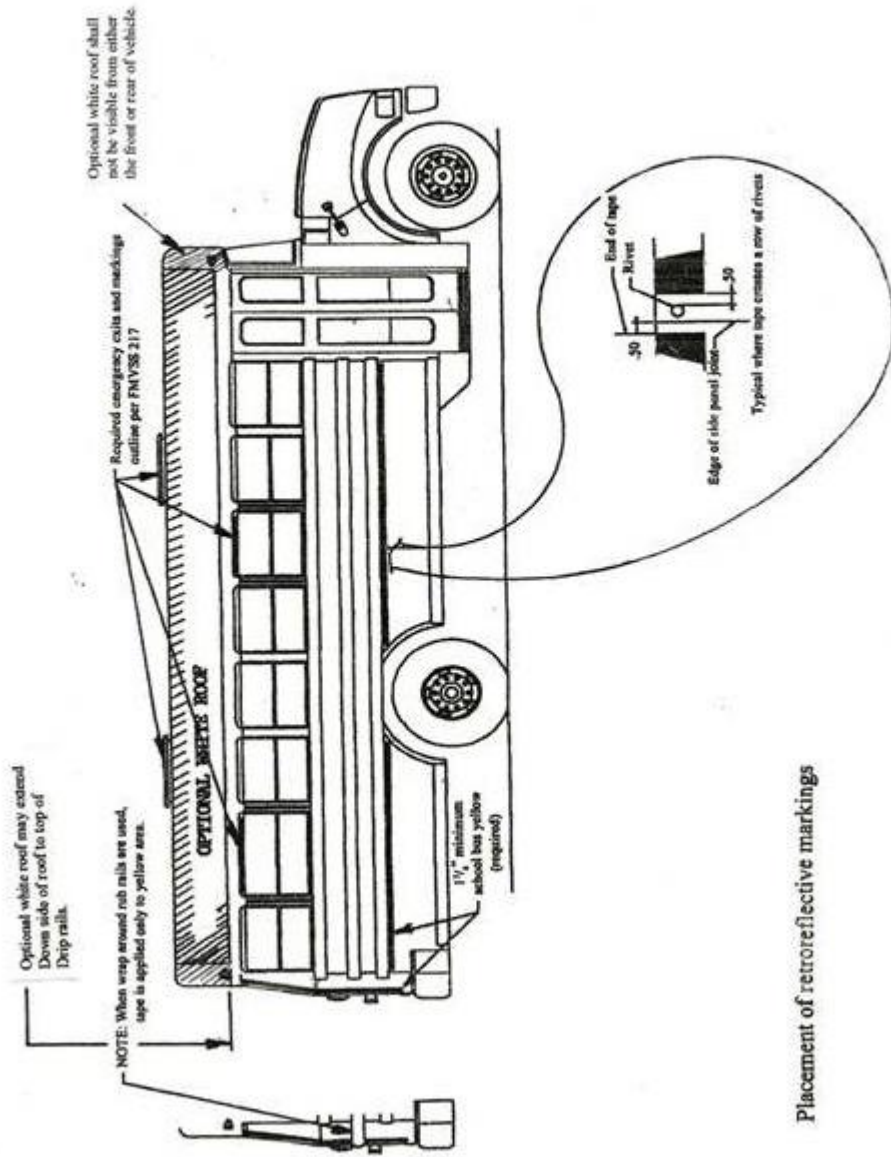

ACEMENT OF RETROREFLECTIVE MARKINGS AND WHITE ROOF

PL

PERIMETER MARKINGS PER NATIONAL SPECIFICATIONS

REQUIRED EMERGENCY EXIT

PERIMETER MARKINGS PER FMVSS 217

MAXIMUM 12 inch x 30 inch SCHOOL BUS YELLOW BACKGROUND WITH BLACK LETTERING (REQUIRED)

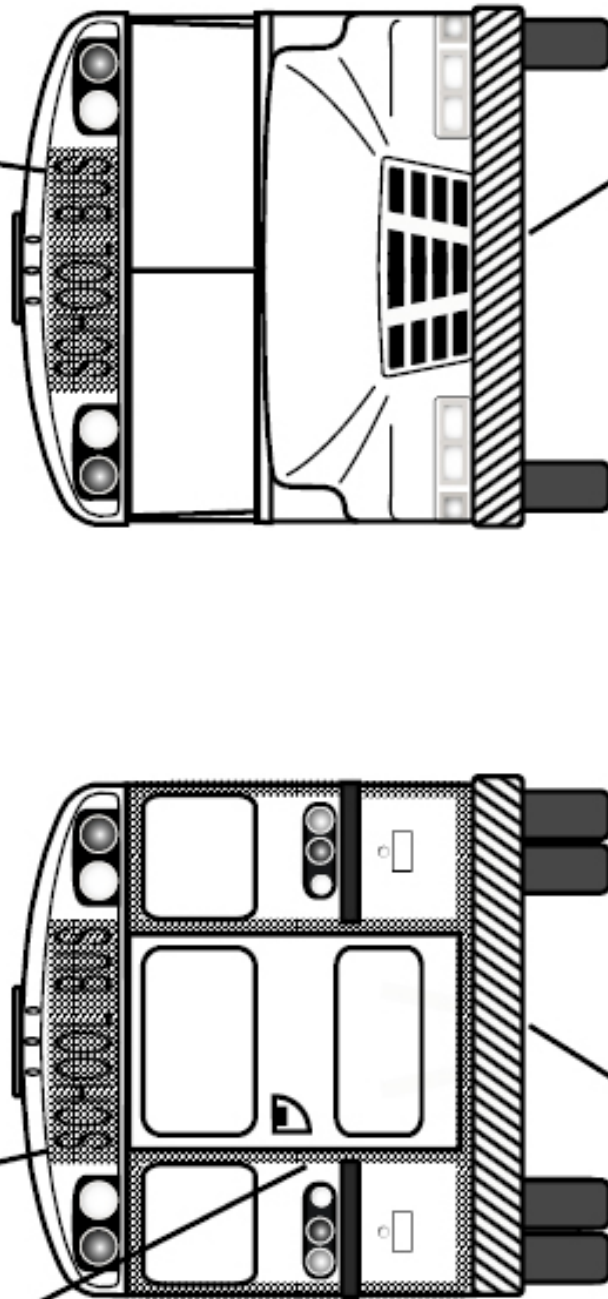

MAXIMUM 2 INCH NON-CONTRASTING COLOR (i.e., SHOWS BLACK DURING DAYLIGHT HOURS) (OPTIONAL)

PLACEMENT OF RETROREFLECTIVE MARKINGS

NOISE TEST PROCEDURE

- A. The vehicle is located so that no other vehicle or signboard, building, hill or other large reflecting surface is within 15.2 m (50 feet) of the occupant's seating position.
- B. All vehicle doors, windows and ventilators are closed.
- C. All power-operated accessories are turned off.
- D. The driver is in the normal seated driving position and the person conducting the test is the only other person in the vehicle.
- E. A sound level meter is used that is set at the "A-weighting fast" meter response and meets the requirements of:
 1. The American National Standards Institute, Standard ANSI S1.4-1971: *Specifications for Sound Level Meters*, for Type 1 Meters or
 2. The International Electrotechnical Commission (IEC), Publication No. 179 (1973): *Precision Sound Level Meters*.
- F. The microphone is located so that it points vertically upward 6 inches to the right and directly in line with, and on the same plane as, the occupant's ear adjacent to the primary noise source.
- G. If the motor vehicle's engine radiator fan drive is equipped with a clutch or similar device that automatically either reduces the rotational speed of the fan or completely disengages the fan from its power source in response to reduced engine cooling loads, the vehicle may be parked before testing with its engine running at high idle or any other speed the operator chooses for sufficient time, but not more than 10 minutes, to permit the engine radiator fan to automatically disengage.
- H. With the vehicle's transmission in neutral gear, the engine is accelerated to:
 1. Its maximum governed speed, if it is equipped with an engine governor or
 2. Its speed at its maximum rated horsepower, if it is not equipped with an engine governor and the engine is stabilized at that speed.
- I. The A-weighted sound level reading on the sound level meter for the stabilized engine speed condition referred to in H.1. or H.2., above, is observed and, if it has not been influenced by extraneous noise sources, is recorded.
- J. The vehicle's engine speed is returned to idle and the procedures set out in paragraphs H. and I. are repeated until 2 maximum sound levels within 2 dBA of each other are recorded. The 2 maximum sound level readings are then averaged; and
- K. The average obtained in accordance with paragraph J., with a value of 2 dBA subtracted therefrom to allow for variations in the test conditions and in the capabilities of meters, is the vehicle's interior sound level at the driver's seating position for the purposes of determining compliance with the requirements of this test procedure.

RETROREFLECTIVE SHEETING DAYTIME COLOR SPECIFICATION

The daytime color of the RETROREFLECTIVE sheeting used to enhance school bus safety requires different color tolerances in order to assure optimum safety benefit, as well as to be consistent with the color of the school bus. The color of the RETROREFLECTIVE sheeting shall conform to the table below when samples applied to aluminum test panels are measured as specified in ASTM E1164. For colorimetric measurements, material is illuminated by Standard Illuminant D65 at an angle of 45 degrees with the normal to the surface the observations are made in the direction of the normal (45/0 degree geometry). The inverse (0/45 degree geometry) with the illuminant at the normal to the surface and the observations at 45 degrees with the normal to the surface may also be used. For materials which are directionally sensitive (e.g., prismatic sheeting), the colorimetric measurements are made using circumferential illumination and viewing and the various measurements are averaged. Calculations shall be done in accordance with ASTM E308 using the CIE 1931 (2 degree) Standard Observer.

Retroreflective Sheeting Daytime Color
 Chromaticity Coordinates of Corner Points
 Determining the Permitted Color Area

	1	2	3	4
Yellow X	0.484	0.513	0.517	0.544
Y	0.455	0.426	0.482	0.455
Luminance Factor (Y%)	Minimum 10.0		Maximum 36.0	

SCHOOL BUS SEAT UPHOLSTERY FIRE BLOCK TEST

A. Test Chamber

1. Cross Section

The suggested test chamber is the same cross section as the bus body in which seats are used with the rear section on each end. If a bus section is not used, the cross section is to be 91±1 inch in width x 75 inches ±3 inches in height. There shall be a door, which does not provide ventilation, in the center of each end of the test chamber. The doors shall be 38±3 inches in width and 53±3 inches in height and include a latch to keep the doors closed during the test. (See Figure 1.)

2. Length

The length of the test chamber shall allow three rows of seats at the minimum spacing recommended by the installer. (See Figure 1, Detail A.) In order that different types of seats may be tested in the same chamber, a length tolerance of plus 45 inches is allowed.

3. Ventilation

- a. One ventilation opening shall be in each end of the test chamber and shall be 325 square inches ±25 square inches. The bottom of the opening shall be 30 inches ±3 inches above the chamber floor. Ventilation openings shall be on the same side of the test chamber. (See Figure 1.)
- b. There shall be no ventilation openings along the length of the test chamber.
- c. A forced-air ventilation system may not be used.
- d. Baffles shall be used to prevent wind from blowing directly into the ventilation openings.

4. Camera View Area

An opening covered with glass shall be provided at the midpoint of the test chamber length for camera viewing. The opening shall allow the camera to view the seat parallel to the seat width. (See Figure 1.)

B. Test Sample

- 1. The sample shall be a fully-assembled seat.
- 2. Record the weight of all padding and upholstery prior to assembly. Record the weight of the fully-assembled seat.

C. Ignition Source

A paper grocery bag with dimensions of approximately 7x11x18 inches is used to contain double sheets of newsprint (black print only, approximately 22x28inches). The total combined weight of bag and newspaper shall be seven ounces ±0.5 ounces.

D. Test Procedure

1. Install three seats in the test chamber at minimum spacing, per installer recommendation. Seats shall be perpendicular to the dimension indicated as “length” in Figure 1. Install so that seat frames will not fall during the test. Seat width shall be determined so that maximum passenger capacity per row (two seats) for the seat style shall be tested.
2. For each test, position the ignition source in the following positions outlined.

Figure 1

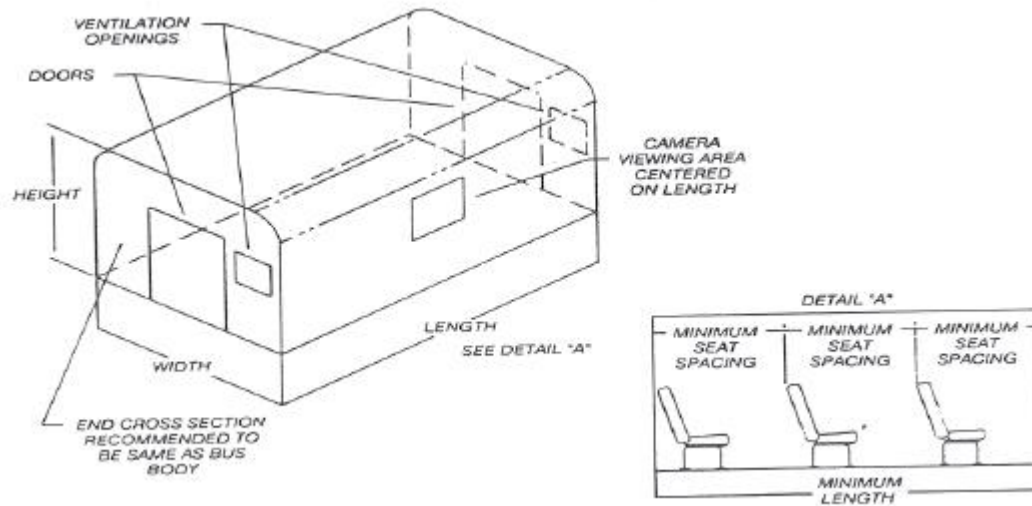

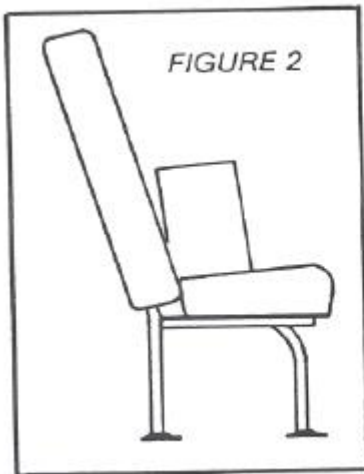

Position A.
Position ignition source with 18-inch dimension in contact with the seat cushion and touching the seat back. Center the bag on top of the cushion. (See Figure 2.)

214

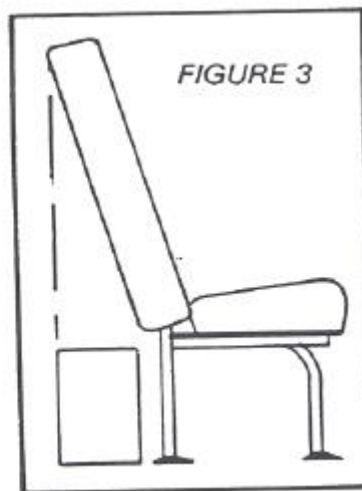

Position B.
Position the ignition source on the floor behind the seat with 18-inch side resting on the floor and parallel to seat width, centered on width so that the rear of bag does not extend beyond the rear seat back. (See Figure 3.)

Position C.
Position the ignition source on the floor on the aisle side of the seat with 18-inch dimension on the floor and perpendicular to the seat width touching the seat leg, with centerline of the bag at the center of the seat back. (See Figure 4.)

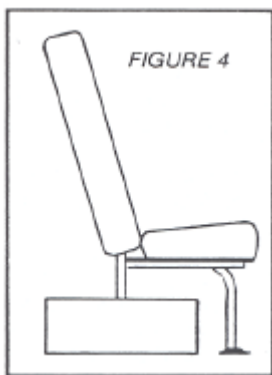

3. A wooden match shall be used to light the ignition source. Time the test, beginning when the ignition source is on fire and ending when all flames are out.
4. After each ignition source position test, weigh seat assembly, including loose material which has fallen off the seat onto the floor.

E. Performance Criteria

For each ignition source position test, the seat tested must meet all of the following criteria.

A new seat specimen may be used for each ignition source position test.

1. Maximum time from ignition to flameout shall be 8 minutes.
2. Flame shall not spread to any other seat with the ignition source in Position A and Position C.
3. Weight loss may not exceed 10% of the pretest weight of padding and upholstery.
Padding and upholstery may be combined in the form of integrally bonded seat foam.