

**OKLAHOMA SCHOOL TESTING PROGRAM
OKLAHOMA CORE CURRICULUM TESTS**

**Test and ITEM
SPECIFICATIONS**

Mathematics
Grade 8

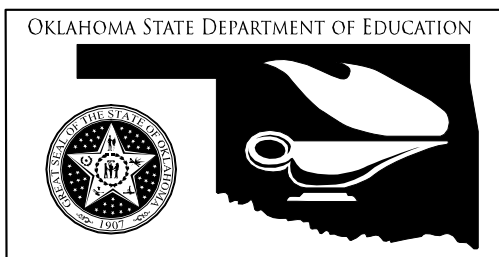
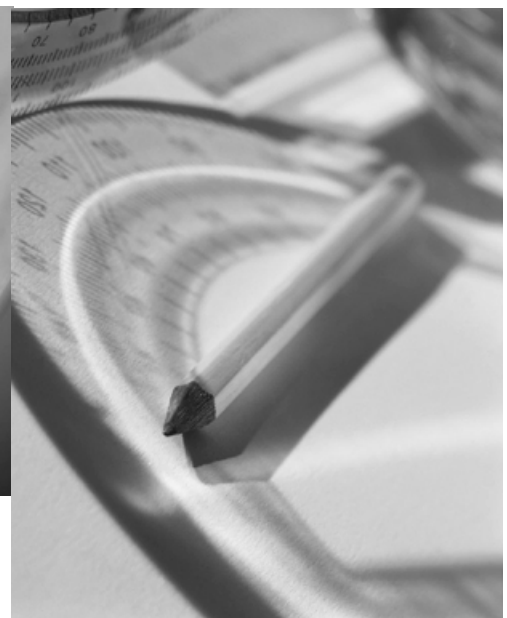

Oklahoma State Department of Education
Oklahoma City, Oklahoma

Revised
August 2013

OKLAHOMA CORE CURRICULUM TESTS

TEST AND ITEM SPECIFICATIONS

Table of Contents

| | |
|---|-----------|
| Purpose..... | 1 |
| Test Structure, Format, and Scoring | 2 |
| Test Alignment with the Oklahoma Academic Standards..... | 2 |
| Test Blueprint | 3 |
| Depth of Knowledge Assessed by Test Items | 4 |
| Universal Test Design Considerations | 5 |
| Testing Schedules..... | 5 |
| Multiple-Choice Item Guidelines..... | 7 |
| Stimulus Materials..... | 7 |
| General Considerations..... | 8 |
| Vocabulary | 9 |
| Overview of Item Specifications..... | 10 |
| Mathematics Content Standards | 11 |
| Mathematics Process Standards | 13 |
| Sample Test Items by Standard..... | 15 |

Purpose

The purpose of the Grade 8 Mathematics Test is to measure Oklahoma eighth-grade students' level of proficiency in mathematics. On the test, students are required to respond to a variety of items linked to the eighth-grade mathematics content standards identified in the Oklahoma Academic Standards (OAS). Each Mathematics Test form tests each identified content standard and objective listed below. The following standards and objectives are intended to summarize the knowledge as identified in the Oklahoma Academic Standards.

| OAS Content Standards and Objectives |
|--|
| Algebraic Reasoning: Patterns and Relationships <ul style="list-style-type: none"> • Equations (1.1) • Inequalities (1.2) |
| Number Sense and Operation <ul style="list-style-type: none"> • Number Sense (2.1) • Number Operations (2.2) |
| Geometry <ul style="list-style-type: none"> • Three Dimensional Figures (3.1) • Pythagorean Theorem (3.2) |
| Measurement <ul style="list-style-type: none"> • Surface Area and Volume (4.1) • Ratio and Proportions (4.2) • Composite Figures (4.3) |
| Data Analysis <ul style="list-style-type: none"> • Data Analysis (5.1) • Central Tendency (5.3) |



Test Structure, Format, and Scoring

The Oklahoma Core Curriculum Tests consist of multiple-choice items. Each multiple-choice item is scored as correct or incorrect. The student's raw score is converted to a scaled score using the number correct method. Of the total items, 10 items are field-test items and do not contribute to the student's scaled score.

| Content Assessment | Total Items | Total Operational Items | Total Field Test Items |
|--|-------------|-------------------------|------------------------|
| Mathematics | 50 | 50 | |
| Reading | 50 | 50 | |
| Science | 55 | 45 | 10 |
| U.S. History, Constitution, and Government | 55 | 45 | 10 |

Test Alignment with the Oklahoma Academic Standards

| Criteria for Aligning the Test with the OAS Standards and Objectives |
|--|
| <p>1. Categorical Concurrence The test is constructed so that there are at least six items measuring each OAS standard. The number of items is based on estimating the number of items that could produce a reasonably reliable estimate of a student's mastery of the content measured.</p> |
| <p>2. Depth of Knowledge Consistency The test is constructed using items from a variety of Depth of Knowledge levels that are consistent with the processes students need in order to demonstrate proficiency for each OAS objective.</p> |
| <p>3. Range of Knowledge Correspondence The test is constructed so that at least 75% of the objectives for an OAS standard of the have at least one corresponding assessment item.</p> |
| <p>4. Balance of Representation The test is constructed according to the Test Blueprint which reflects the degree of representation given on the test to each OAS standard and/or OAS objective in terms of the percent of total test items measuring each standard and the number of test items measuring each standard and/or objective. The test construction shall yield a balance of representation with an index of 0.7 or higher of assessed objectives related to a standard.</p> |
| <p>5. Source of Challenge Each test item is constructed in such a way that the major cognitive demand comes directly from the targeted OAS objective or OAS concept being assessed, not from specialized knowledge or cultural background that the test-taker may bring to the testing situation.</p> |

**Oklahoma School Testing Program
Oklahoma Core Curriculum Tests
Grade 8 Mathematics
Test Blueprint
School Year 2013-2014**

The Test Blueprint reflects the degree to which each standard and objective of the Oklahoma Academic Standards is represented on the test. The overall distribution of operational items in a test form is intended to look as follows:

| Standards and Objectives | Ideal Number of Items | Ideal Percentage of Items | Reporting Category |
|--|-----------------------|---------------------------|--------------------|
| 1.0 Algebraic Reasoning: Patterns and Relationships | 16 | 32% | 16 |
| 1.1 Equations | 10-12 | | 10-12 |
| 1.2 Inequalities | 4-6 | | 4-6 |
| | | | |
| 2.0 Number Sense and Operation | 11 | 22% | 11 |
| 2.1 Number Sense | 3-4 | | 3-4 |
| 2.2 Number Operations | 7-8 | | 7-8 |
| | | | |
| 3.0 Geometry | 9 | 18% | 9 |
| 3.1 Three Dimensional Figures | 5 | | 5 |
| 3.2 Pythagorean Theorem | 4 | | 4 |
| | | | |
| 4.0 Measurement | 7 | 14% | 7 |
| 4.1 Surface Area and Volume | 3 | | 5 |
| 4.2 Ratio and Proportions | 2 | | |
| 4.3 Composite Figures | 2 | | 2 |
| | | | |
| 5.0 Data Analysis | 7 | 14% | 7 |
| 5.1 Data Analysis | 3 | | 3 |
| 5.3 Central Tendency | 4 | | 4 |
| | | | |
| Total Test | 50 | 100% | 50 |

- A minimum of 4 items is required to report results for an objective, and a minimum of 6 items is required to report a standard.
- Percentages are approximations and may result in a sum other than 100 due to rounding.
- Objectives have been grouped for reporting purposes only.
- The Oklahoma Academic Standards correspond to the *PASS* standards.

Depth of Knowledge Assessed by Test Items

The Oklahoma Core Curriculum Tests will, as closely as possible, reflect the following “Depth of Knowledge” distribution of items.

| Grades 3–5 | |
|---------------------------------|------------------|
| Depth of Knowledge | Percent of Items |
| Level 1—Recall and Reproduction | 20–25% |
| Level 2—Skills and Concepts | 65–70% |
| Level 3—Strategic Thinking | 5–15% |

| Grades 6–8 | |
|---------------------------------|------------------|
| Depth of Knowledge | Percent of Items |
| Level 1—Recall and Reproduction | 10–15% |
| Level 2—Skills and Concepts | 65–70% |
| Level 3—Strategic Thinking | 15–25% |

Level 1 (Recall and Reproduction) requires the student to recall facts, terms, definitions, or simple procedures, and to perform simple algorithms or apply formulas. One-step, well-defined, or straight algorithmic procedures should be included at this level.

Level 2 (Skills and Concepts) requires the student to make some decision as to how to approach the problem or activity. Level 2 activities include: making observations and collecting data; classifying, comparing, and organizing data; and organizing and displaying data in tables, charts, and graphs.

Level 3 (Strategic and Extended Thinking) requires complex reasoning, planning, developing, using evidence, and a higher level of thinking. These processes typically require an extended amount of time. The cognitive demands of the item should be high and the work should be complex. In order to be considered at this level, students are required to make several connections (relate ideas *within* the content area or *among* the content areas) and select one approach among many alternatives as to how the situation should be solved. Level 3 activities include: making conjectures; drawing conclusions from observations; citing evidence; developing a logical argument for concepts; explaining phenomena in terms of concepts; and using concepts to solve non-routine problems.

Note—The descriptions are adapted from Review Background Information and Instructions, Standards and Assessment Alignment Analysis, CCSSO TILSA Alignment Study, May 21–24, 2001, Version 2.0.

For an extended description of each Depth of Knowledge level, see the student assessment Web site at <<http://www.ok.gov/sde/>>.

Universal Test Design Considerations

Universal design, as applied to assessments, is a concept that allows the widest possible range of students to participate in assessments and may even reduce the need for accommodations and alternative assessments by expanding access to the tests themselves. In the Oklahoma Core Curriculum Tests, modifications have been made to some items that simplify and clarify instructions, and provide maximum readability, comprehensibility, and legibility. This includes such things as reduction of language load in content areas other than Reading, increased font size, fewer items per page, and boxed items to assist visual focus. Reading tests will have vocabulary at grade level. In all other tests, the vocabulary level will be below the grade being tested except for content words. Grades 3 and 4 will be one grade level below, and grades 5, 6, 7, and 8 will be two grade levels below. These modifications are evident in the sample items included in this document.

Testing Schedules

Each subject test, except Writing, is divided into two separate sections at grades 3, 4, and 5. These two sections of the test may be administered on the same day with a break given between the sections or on consecutive days. At grades 6, 7 and 8, each subject area test is meant to be administered in a separate session. Students may be given additional time if needed, but additional time will be given as an extension of the same testing period, not at a different time.

| Writing Test | |
|---|-----------------------|
| | <u>Approximately:</u> |
| Distributing books, filling in the Student Demographic Page, reading directions | 20 minutes |
| Administering the Writing Test (not timed) | 50 minutes |
| Total: | 70 minutes |

| Grade 8 Mathematics | | Grade 8 Reading | |
|--|-----------------------|--|-----------------------|
| Test Session | | Test Session | |
| | <u>Approximately:</u> | | <u>Approximately:</u> |
| Distributing books, filling in the Student Demographic Page, reading directions | 20 minutes | Distributing books, reading directions | 15 minutes |
| Administering the Mathematics Test; no calculators are allowed during this test | 60–80 minutes | Administering the Reading Test | 95–115 minutes |
| Total: | 80–100 minutes | Total: | 110–130 minutes |

| Grade 8 U.S. History, Constitution, and Government | | Grade 8 Science | |
|---|-----------------------|--|-----------------------|
| Test Session | | Test Session | |
| | <u>Approximately:</u> | | <u>Approximately:</u> |
| Distributing books, filling in the Student Demographic Page, reading directions | 20 minutes | Distributing books, reading directions | 15 minutes |
| Administering the Test | 60–80 minutes | Administering the Test | 60–80 minutes |
| Total: | 80–100 minutes | Total: | 75–95 minutes |

Multiple-Choice Item Guidelines

- All item stems clearly indicate what is expected in an item to help students focus on selecting a response.
- Each multiple-choice item has a stem (question, statement, or incomplete statement, and/or graphic component) and four answer (or completion) options, only one of which is correct.
- Multiple-choice item stems present a complete problem so that students know what to do before looking at the answer choices; students should not need to read all answer choices before knowing what is expected.
- Art incorporated within an item must be functional and assist students in determining the correct response.

In summary, test items assess whether students: understand relevant concepts and procedures; communicate their understandings effectively in content specific terms; approach problems; and develop viable solutions.

Stimulus Materials

Stimulus materials are the passages, graphs, models, figures, etc. that students must read and examine in order to respond to items. The following characteristics are necessary for stimulus materials:

1. When students are given information, data, or an experimental setup to evaluate, they should know the research question and the purpose of the research.
2. Tables, graphs, reading passages, and illustrations provide sufficient information for assessment of multiple standards.
3. Stimulus materials for a set of items may be a combination of multiple stimuli.
4. Information in stimulus materials is representative of concepts and principles described in the Oklahoma Academic Standards.
5. For conceptual items, stimulus materials are necessary but not conceptually sufficient for student response.
6. There is a balance of graphic and textual stimulus materials within a test form. At least 50% of the items have appropriate pictorial and graphical representations. Graphs, tables, or figures are clearly associated with their intended items. Graphics appear either on the same page as the stimulus or on the facing page.
7. The stimuli avoid subject matter that might prompt emotional distress on the part of the students.
8. Permission to use stimuli from copyrighted material is obtained as necessary by the testing vendor.

General Considerations

It is necessary to create test items that are reliable, fair, and targeted to the standards of the Oklahoma Academic Standards listed on the following pages. There are some general considerations and procedures for effective item development. These considerations include, but are not limited to, the following:

1. Each test form contains items assessing standards and objectives listed in the Test Blueprint for the specific grade and content area. In the Oklahoma Academic Standards document, asterisks have been used to identify standards and objectives that must be assessed by the local school district.
2. Test items that assess each standard are not limited to one particular type of response format. Each item begins with a stem that asks a question or poses a clear problem. Stems may include incomplete sentences in order to reduce unnecessary repetition of text.
3. Test items attempt to focus on content that is authentic and that grade-level students can relate to and understand.
4. Test items are worded precisely and clearly. The more focused an item, the more reliable and fair it will be, and the more likely all students will understand what is required of them.
5. All items are reviewed to eliminate language that is biased or is otherwise likely to disadvantage a particular group of students. That is, items do not display unfair representations of gender, race, ethnicity, disability, culture, or religion; nor do items contain elements that are offensive to any such groups.
6. All multiple-choice answer options, including the correct response and distractors, are similar in length and syntax. Students should not be able to rule out a wrong answer or identify a correct response solely because it looks or sounds different from the other answer choices. Distractors are created so that students reason their way to the correct answer rather than simply identify incorrect responses because of a distractor's obviously inappropriate nature. Distractors should always be plausible (but incorrect) in the context of the item stem. Correct responses are reasonably distributed among As, Bs, Cs, and Ds. The distractors adopt the language and sense of the material in the selection. Test items focus on reading skills and comprehension strategies, avoiding measurement of a student's feelings or values.
7. Items deal with issues and details that are of consequence in the stimulus and central to students' understanding and interpretation of the stimulus.
8. To the greatest extent possible, no item or response choice clues the answer to any other item. No item stem or answer option provides clues to any other item's answer, nor is the same fact of the passage assessed more than once, including the same vocabulary or technical term.
9. Test items are tied closely and particularly to the stimuli from which they derive, so that the impact of outside (prior) knowledge, while never wholly avoidable, is minimized.
10. The responses "Both of the above," "All of the above," "None of the above," and "Neither of the above" are not used.

11. Most stems are positively worded—avoiding the use of the word not. If a negative is required, the format is “All of the following . . . except.”
12. The material presented is balanced, culturally diverse, well-written, and of interest to students. The stimuli and items are presented fairly in order to gain a true picture of students’ skills.
13. Across all forms, a balance of gender and active/passive roles by gender is maintained.
14. No resource materials or calculators may be used by students during the test.

Vocabulary

No single source is available to determine the reading level of various words. Therefore, the appropriateness and difficulty of a word is determined in various ways. Vocabulary words are checked in the following: *EDL Core Vocabularies in Reading, Mathematics, Science, and Social Studies*; *Basic Reading Vocabularies*; the *Living Word*; or other reliable readability sources. In addition to using the aforementioned printed resources to assist in creating vocabulary items, each vocabulary item must be approved by Oklahoma’s Content Review Committee. The committee, comprised of Oklahoma educators from across the state, reviews proposed vocabulary items for grade level appropriateness. Reading tests will have vocabulary at grade level. In all other tests, the vocabulary level will be below the grade being tested except for content words. Grades 3 and 4 will be one grade level below, and grades 5, 6, 7, and 8 will be two grade levels below.

All items developed using these specifications are reviewed by Oklahoma educators and approved by the Oklahoma State Department of Education. The distribution of newly developed items is based on content and process alignment, difficulty, cognitive ability, percentage of art/graphics, and grade-level appropriateness as determined by an annual Item Development Plan approved by the Oklahoma State Department of Education.

Overview of Item Specifications

For each OAS standard, item specifications are organized under the following headings:

- OAS Standard and OAS Objective
- Item Specifications
 - a. Emphasis
 - b. Stimulus Attributes
 - c. Format
 - d. Content Limits
 - e. Primary Process Standards
 - f. Distractor Domain
 - g. Sample Test Items

The headings “OAS Standard” and “OAS Objective” state the standard and objective being measured as found in the eighth-grade mathematics section of the Oklahoma Academic Standards document.

The heading “Item Specifications” highlights important points about the items’ emphasis, stimulus attributes, format, content limits, primary process standards, distractor domain, and sample test items. Although it is sometimes possible to score single items for more than one concept, all items in these tests are written to address a single content standard as the primary concept.

Note about the Item Specifications and Sample Test Items:

With the exception of content limits, the item specifications give suggestions of what might be included and do not give an exhaustive list of what can be included. The sample test items are not intended to be definitive in nature or construction—the stimuli and the test items that follow them may differ from one test form to another, as may their presentations.

Oklahoma Academic Standards

MATHEMATICS CONTENT STANDARDS

Grade 8

Asterisks (*) have been used to identify standards and objectives that must be assessed by the local school district. All other skills may be assessed by the Oklahoma School Testing Program (OSTP).

Standard 1: Algebraic Reasoning: Patterns and Relationships—The student will graph and solve linear equations and inequalities in problem solving situations.

1. Equations

- a. Model, write, and solve multi-step linear equations with one variable using a variety of methods to solve application problems.
- b. Graph and interpret the solution to one- and two-step linear equations on a number line with one variable and on a coordinate plane with two variables.
- c. Predict the effect on the graph of a linear equation when the slope or y-intercept changes (e.g., make predictions from graphs, identify the slope or y-intercept in the equation $y = mx + b$ and relate to a graph).
- d. Apply appropriate formulas to solve problems (e.g., $d = rt$, $I = prt$).

2. Inequalities: Model, write, solve, and graph one- and two-step linear inequalities with one variable.

Standard 2: Number Sense and Operation—The student will use numbers and number relationships to solve a variety of problems.

1. Number Sense: Represent and interpret large numbers and numbers less than one in exponential and scientific notation.

2. Number Operations

- a. Use the rules of exponents, including integer exponents, to solve problems (e.g., $7^2 \cdot 7^3 = 7^5$, $3^{-10} \cdot 3^8 = 3^{-2}$).
- b. Solve problems using scientific notation.
- c. Simplify numerical expressions with rational numbers, exponents, and parentheses using order of operations.

Standard 3: Geometry—The student will use geometric properties to solve problems in a variety of contexts.

1. Construct models, sketch (from different perspectives), and classify solid figures such as rectangular solids, prisms, cones, cylinders, pyramids, and combined forms.
2. Develop the Pythagorean Theorem and apply the formula to find the length of line segments, the shortest distance between two points on a graph, and the length of an unknown side of a right triangle.

Standard 4: Measurement—The student will use measurement to solve problems in a variety of contexts.

1. Develop and apply formulas to find the surface area and volume of rectangular prisms, triangular prisms, and cylinders (in terms of pi).
2. Apply knowledge of ratio and proportion to solve relationships between similar geometric figures.
3. Find the area of a “region of a region” for simple composite figures and the area of cross sections of regular geometric solids (e.g., area of a rectangular picture frame).

Standard 5: Data Analysis—The student will use data analysis, probability, and statistics to interpret data in a variety of contexts.

1. Data Analysis: Select, analyze and apply data displays in appropriate formats to draw conclusions and solve problems.
- *2. Probability: Determine how samples are chosen (random, limited, biased) to draw and support conclusions about generalizing a sample to a population (e.g., is the average height of a men’s college basketball team a good representative sample for height predictions?).
3. Central Tendency: Find the measures of central tendency (mean, median, mode, and range) of a set of data and understand why a specific measure provides the most useful information in a given context.

Oklahoma Academic Standards**MATHEMATICS PROCESS STANDARDS****Grade 8****Process Standard 1: Problem Solving**

1. Develop and test strategies to solve practical, everyday problems which may have single or multiple answers.
2. Use technology to generate and analyze data to solve problems.
3. Formulate problems from situations within and outside of mathematics and generalize solutions and strategies to new problem situations.
4. Evaluate results to determine their reasonableness.
5. Apply a variety of strategies (e.g., restate the problem, look for a pattern, diagrams, solve a simpler problem, work backwards, trial and error) to solve problems, with emphasis on multistep and nonroutine problems.
6. Use oral, written, concrete, pictorial, graphical, and/or algebraic methods to model mathematical situations.

Process Standard 2: Communication

1. Discuss, interpret, translate (from one to another) and evaluate mathematical ideas (e.g., oral, written, pictorial, concrete, graphical, algebraic).
2. Reflect on and justify reasoning in mathematical problem solving (e.g., convince, demonstrate, formulate).
3. Select and use appropriate terminology when discussing mathematical concepts and ideas.

Process Standard 3: Reasoning

1. Identify and extend patterns and use experiences and observations to make suppositions.
2. Use counterexamples to disprove suppositions (e.g., all squares are rectangles, but are all rectangles squares?).
3. Develop and evaluate mathematical arguments (e.g., agree or disagree with the reasoning of other classmates and explain why).
4. Select and use various types of reasoning (e.g., recursive [loops], inductive [specific to general], deductive [general to specific], spatial, and proportional).

Process Standard 4: Connections

1. Apply mathematical strategies to solve problems that arise from other disciplines and the real world.
2. Connect one area or idea of mathematics to another (e.g., relate equivalent number representations to each other, relate experiences with geometric shapes to understanding ratio and proportion).

Process Standard 5: Representation

1. Use a variety of representations to organize and record data (e.g., use concrete, pictorial, and symbolic representations).
2. Use representations to promote the communication of mathematical ideas (e.g., number lines, rectangular coordinate systems, scales to illustrate the balance of equations).
3. Develop a variety of mathematical representations that can be used flexibly and appropriately (e.g., base-10 blocks to represent fractions and decimals, appropriate graphs to represent data).
4. Use a variety of representations to model and solve physical, social, and mathematical problems (e.g., geometric objects, pictures, charts, tables, graphs).

Oklahoma Academic Standards

Sample Test Items by Standard

Grade 8

OAS Standard:

Standard 1: Algebraic Reasoning: Patterns and Relationships—The student will graph and solve linear equations and inequalities in problem solving situations.

OAS Objective:

1. Equations
 - a. Model, write, and solve multi-step linear equations with one variable using a variety of methods to solve application problems.

Item Specifications:Emphasis:

Identify, translate, and analyze attributes of algebraic and geometric representations of lines; write and solve linear equations in mathematical and real-world situations.

Stimulus Attributes:

Test items may include illustrations of the following: coordinate graphs, number lines, balances, and other diagrams.

Format:

Identify, write, and solve multi-step linear equations involved in mathematical and real-world situations.

Content Limits:

Limit to integer or common fraction coefficients

Primary Process Standards:

Process Standard 1: Problem Solving

Process Standard 4: Connections

Process Standard 5: Representation

Distractor Domain:

- Common errors
- Incorrect procedures
- Inappropriate operations with variables

Oklahoma Academic Standards 1.1a Sample Test Items:

Primary Process Standard: 8M1.5

Depth of Knowledge: 2

Correct Answer: C

What value of x makes this equation true?

$$4x - 10 = 18$$

- A** 2
- B** 4
- C** 7
- D** 8

Primary Process Standard: 8M1.6

Depth of Knowledge: 2

Correct Answer: C

Stacey delivers newspapers. She earns \$15 each week plus \$2 for each customer on her route. Which equation can she use to find c , the number of customers she needs to earn exactly \$25 each week?

- A** $15c - 2 = 25$
- B** $15c + 2 = 25$
- C** $2c + 15 = 25$
- D** $2c - 15 = 25$

Primary Process Standard: 8M5.1

Depth of Knowledge: 3

Correct Answer: C

Table of Values

| x | y |
|-----|-----|
| -2 | -1 |
| -1 | 1 |
| 0 | 3 |
| 1 | 5 |
| 2 | 7 |

Which equation could represent the data in the table?

- A** $y = x + 2$
- B** $y = x + 3$
- C** $y = 2x + 3$
- D** $y = 3x + 2$

OAS Standard:

Standard 1: Algebraic Reasoning: Patterns and Relationships—The student will graph and solve linear equations and inequalities in problem solving situations.

OAS Objective:

1. Equations
 - b. Graph and interpret the solution to one- and two-step linear equations on a number line with one variable and on a coordinate plane with two variables.

Item Specifications:Emphasis:

Identify, translate, and analyze attributes of algebraic and geometric representations of lines; solve linear equations in mathematical and real-world situations.

Stimulus Attributes:

Test items may include illustrations of the following: coordinate graphs, number lines, balances, and other diagrams.

Format:

- Translate between algebraic and geometric representations of linear equations
- Analyze attributes of algebraic and geometric representations of linear equations
- Graph one- and two-step linear equations

Content Limits:

- Limit linear equations to integer or common fraction coefficients
- Limit interpretation of solutions to linear equations to simple graphs that require identification of y -intercepts, positive and negative slopes (sign only may change in the options)
- Limit equations to slope-intercept form

Primary Process Standards:

Process Standard 1: Problem Solving

Process Standard 4: Connections

Process Standard 5: Representation

Distractor Domain:

- Common errors
- Incorrect procedures
- Inappropriate operations with variables

Oklahoma Academic Standards 1.1b Sample Test Items:

Primary Process Standard: 8M5.2

Depth of Knowledge: 1

Correct Answer: D

The graph of line l is shown on this coordinate grid.

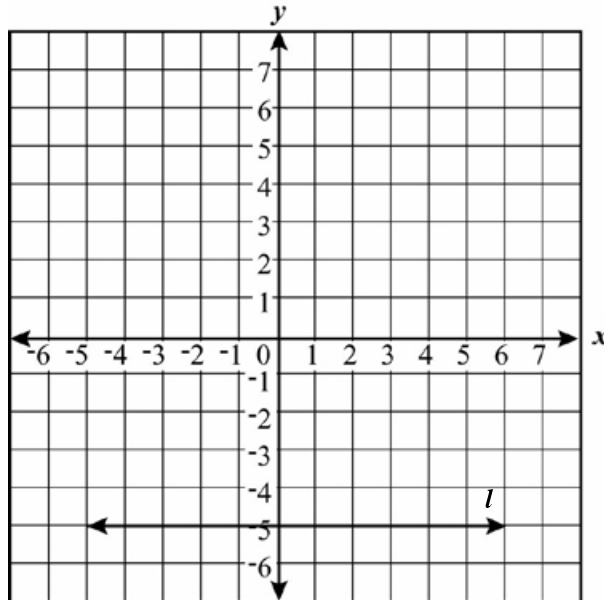

What is the equation of line l ?

- A $x = 5$
- B $x = -5$
- C $y = 5$
- D $y = -5$

Primary Process Standard: 8M5.2

Depth of Knowledge: 2

Correct Answer: C

Which graph best represents the solution to the following equation?

$$4x - 5 = 21$$

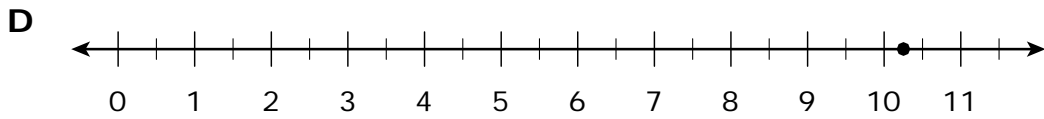
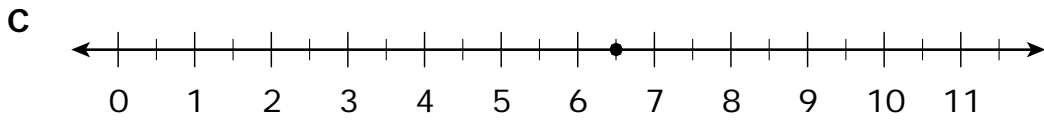
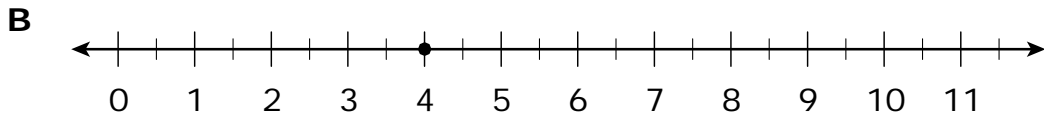
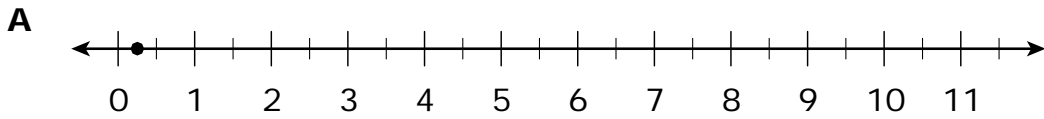

Primary Process Standard: 8M5.3

Depth of Knowledge: 2

Correct Answer: D

Which graph best represents the equation $y = -2x - 2$?

A

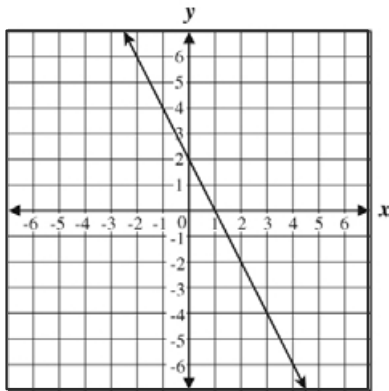

B

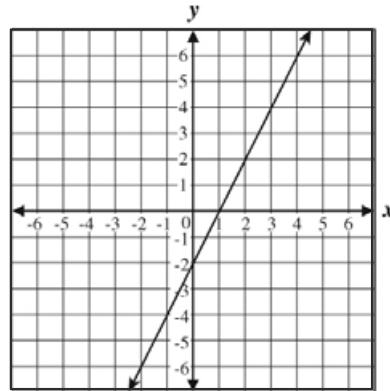

C

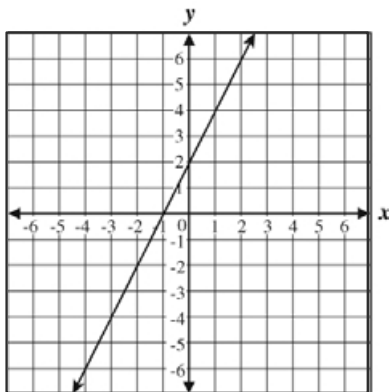

D

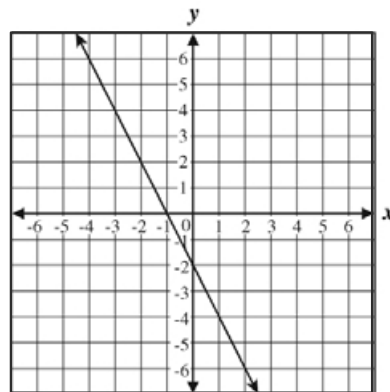

OAS Standard:

Standard 1: Algebraic Reasoning: Patterns and Relationships—The student will graph and solve linear equations and inequalities in problem solving situations.

OAS Objective:

1. Equations
 - c. Predict the effect on the graph of a linear equation when the slope or y-intercept changes (e.g., make predictions from graphs, identify the slope or y-intercept in the equation $y = mx + b$ and relate to a graph).

Item Specifications:Emphasis:

Identify, translate, and analyze attributes of algebraic and geometric representations of lines.

Stimulus Attributes:

Test items may include illustrations of the following: coordinate graphs, number lines, balances, and other diagrams.

Format:

- Translate between algebraic and geometric representations of linear equations
- Analyze attributes of algebraic and geometric representations of linear equations

Content Limits:

- Limit linear equations to integer or common fraction coefficients
- Limit equations to slope-intercept form
- Limit change of slope to opposites, integers, and common fractions, or simple identification of steepness, or closer to vertical or horizontal (without calculation)

Primary Process Standards:

Process Standard 1: Problem Solving

Process Standard 4: Connections

Process Standard 5: Representation

Distractor Domain:

- Common errors
- Incorrect procedures
- Inappropriate operations with variables

Oklahoma Academic Standards 1.1c Sample Test Items:

Primary Process Standard: 8M1.4

Depth of Knowledge: 2

Correct Answer: A

The equation $y = \frac{1}{2}x + 1$ is graphed on this coordinate plane.

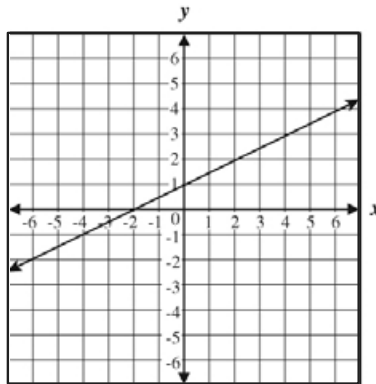

Which graph represents a new equation formed by changing the slope of $y = -\frac{1}{2}x + 1$ to a slope of 4?

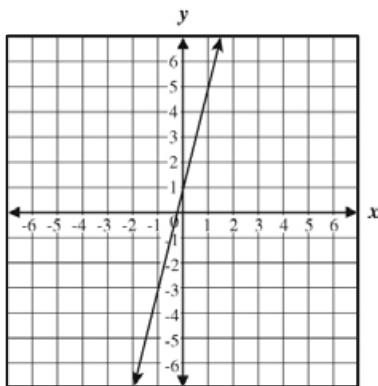
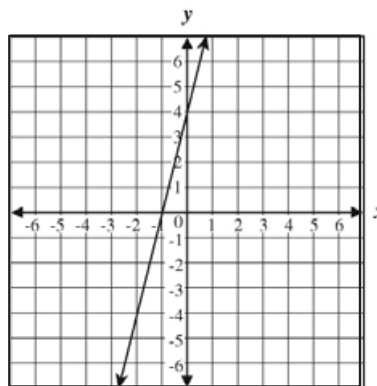
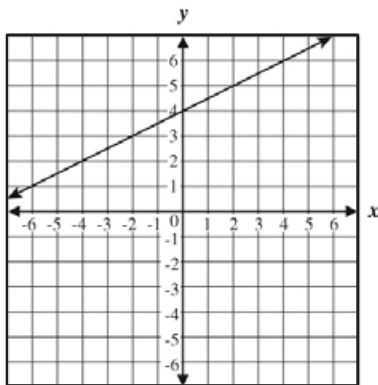
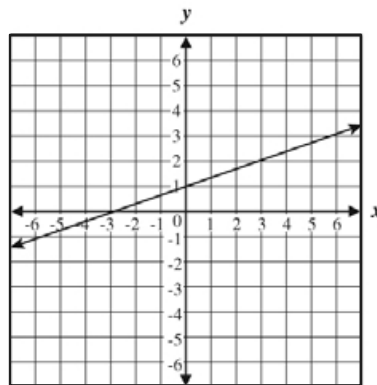
A**B****C****D**

Primary Process Standard: 8M5.2

Depth of Knowledge: 2

Correct Answer: A

The graph of the equation $y = 6x + 1$ is shown on the grid.

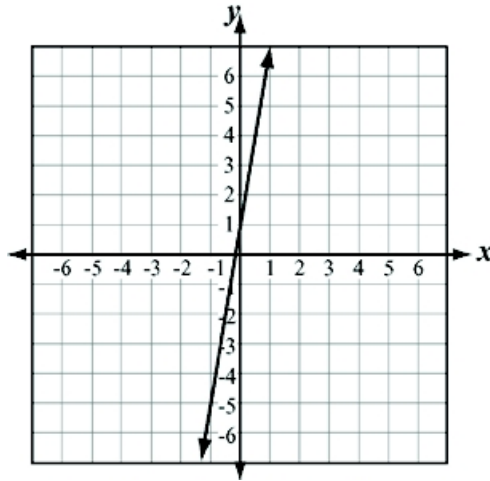

Which graph best represents the equation created when the slope of $y = 6x + 1$ is changed to a slope of 0?

A

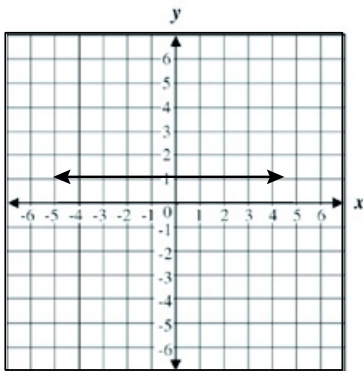

B

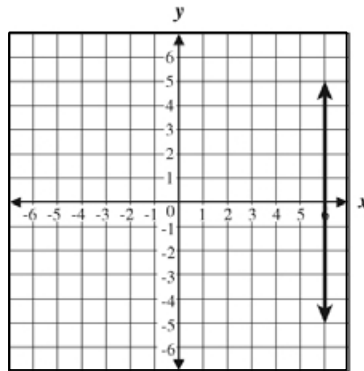

C

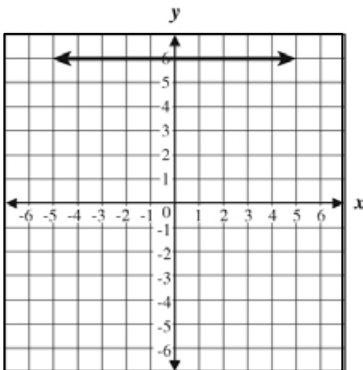

D

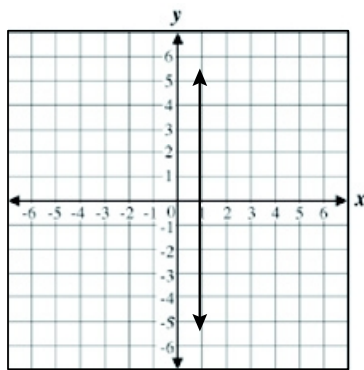

Primary Process Standard: 8M5.2

Depth of Knowledge: 2

Correct Answer: C

Which graph best represents the effect on the graph of $y = 7x + 3$ when the slope is changed to $-\frac{2}{3}$ and the y -intercept remains the same?

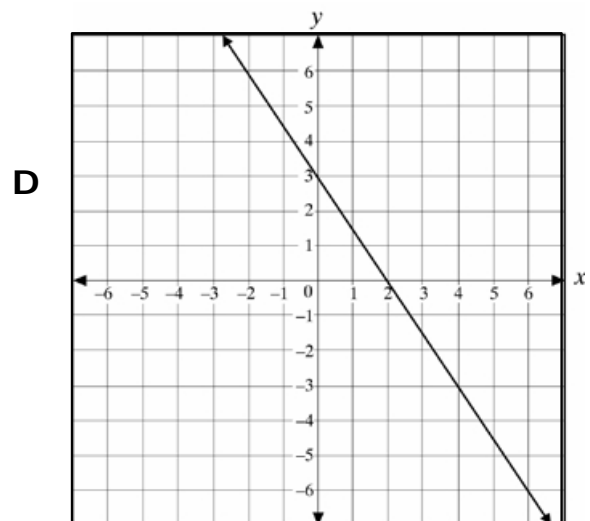
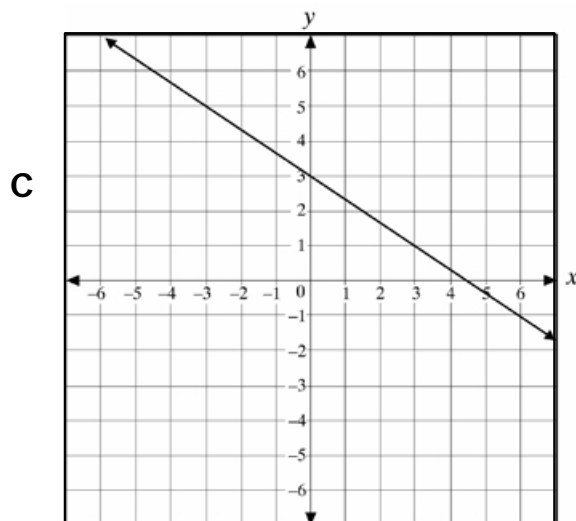
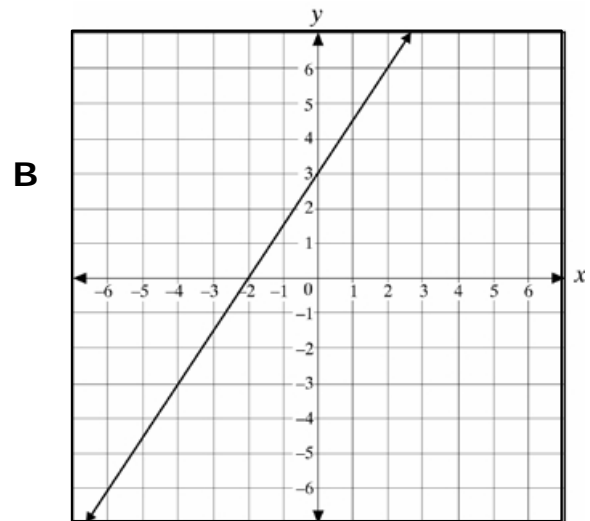
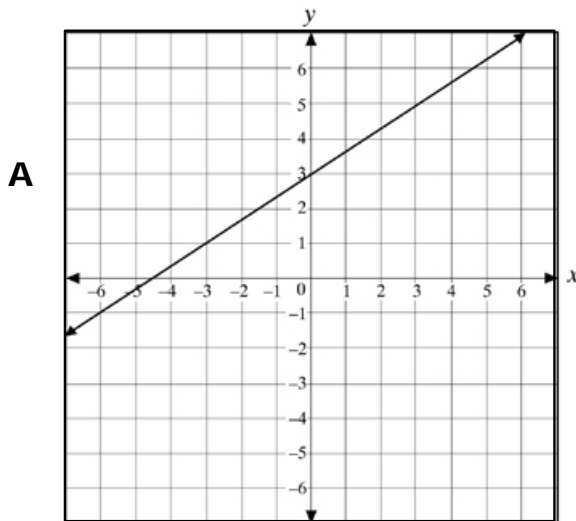

Primary Process Standard: 8M4.2

Depth of Knowledge: 3

Correct Answer: A

The graph of the equation $y = 2x - 6$ is shown.

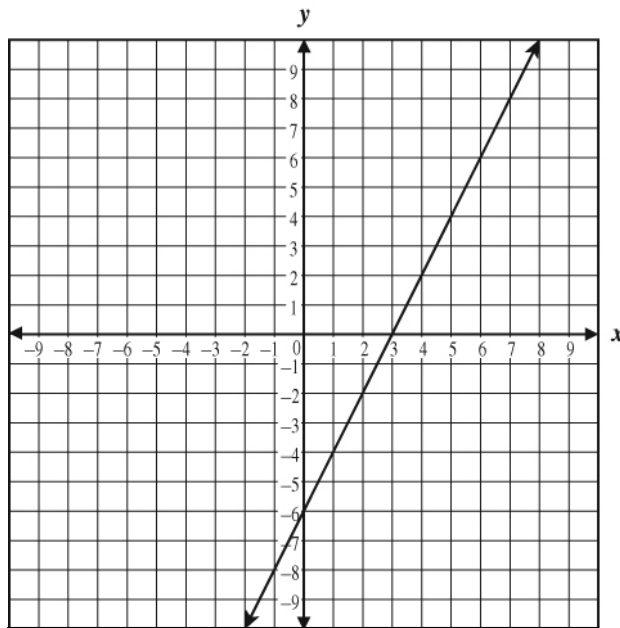

If the slope of the equation is changed to 3 and the y -intercept remains the same, which of these statements is true?

- A** The new graph will intersect the x -axis at a location closer to $(0, 0)$.
- B** The new graph will intersect the x -axis at a location farther from $(0, 0)$.
- C** The new graph will intersect the y -axis at a location closer to $(0, 0)$.
- D** The new graph will intersect the y -axis at a location farther from $(0, 0)$.

OAS Standard:

Standard 1: Algebraic Reasoning: Patterns and Relationships—The student will graph and solve linear equations and inequalities in problem solving situations.

OAS Objective:

1. Equations
 - d. Apply appropriate formulas to solve problems (e.g., $d = rt$, $I = prt$).

Item Specifications:Emphasis:

Identify, select, and apply appropriate formulas.

Stimulus Attributes:

Test items may include illustrations of two- and three-dimensional geometric figures.

Format:

- Select and apply appropriate formulas for mathematical and real-world situations
- Formulas may or may not be given.

Content Limits:

- Limit formulas to those used in real-world situations
- Limit multistep processes to no more than two steps for each component stage

Primary Process Standards:

Process Standard 1: Problem Solving

Process Standard 2: Communication

Process Standard 3: Reasoning

Process Standard 4: Connections

Process Standard 5: Representation

Distractor Domain:

- Common errors
- Use of inappropriate formulas
- Incorrect procedures

Oklahoma Academic Standards 1.1d Sample Test Items:

Primary Process Standard: 8M2.1

Depth of Knowledge: 1

Correct Answer: C

Which of these equations can be used to find r , the speed in miles per hour, of an airplane that traveled 2,000 miles in 5 hours?

A $2,000 = \frac{r}{5}$

B $2,000 = \frac{5}{r}$

C $2,000 = 5r$

D $2,000 = 5 + r$

Primary Process Standard: 8M2.2

Depth of Knowledge: 2

Correct Answer: A

Valerie used 60 feet of fencing to form a rectangular garden. If l is the length of the garden, which formula could be used to find w , the width, in feet, of the garden?

A $w = \frac{60 - 2l}{2}$

B $w = \frac{2l - 2}{60}$

C $w = \frac{2l + 2}{60}$

D $w = \frac{60 + 2l}{2}$

Primary Process Standard: 8M1.6

Depth of Knowledge: 3

Correct Answer: C

The figure below represents a net of a cube. Each face of the cube is x -units wide.

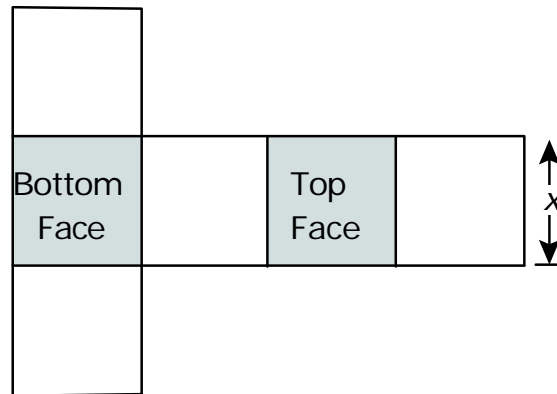

Which formula can be used to find n , the combined area of the top and bottom faces of the cube?

- A $n = \frac{1}{6}x^2$
- B $n = x^2$
- C $n = 2x^2$
- D $n = 4x^2$

Primary Process Standard: 8M4.1

Depth of Knowledge: 3

Correct Answer: D

The Earth travels around the Sun at approximately 30 kilometers per second. At this rate, about how many kilometers does the Earth travel in 2 minutes?

$$d = rt$$

- A 15 kilometers
- B 60 kilometers
- C 1,800 kilometers
- D 3,600 kilometers

OAS Standard:

Standard 1: Algebraic Reasoning: Patterns and Relationships—The student will graph and solve linear equations and inequalities in problem solving situations.

OAS Objective:

2. Inequalities: Model, write, solve, and graph one- and two-step linear inequalities with one variable.

Item Specifications:Emphasis:

Identify, solve, and graph the solutions to 2-step linear inequalities.

Stimulus Attributes:

Test items may include illustrations of the following: number lines, balances.

Format:

- Solve and graph the solution to a 2-step linear inequality
- Identify 2-step inequalities that model mathematical and real-world situations

Content Limits:

- Limit inequalities to integer or common fraction coefficients
- Limit inequalities to 2 steps
- Limit inequalities to only one variable
- Limit inequalities to multiplication and division by integers

Primary Process Standards:

Process Standard 1: Problem Solving

Process Standard 2: Communication

Process Standard 5: Representation

Distractor Domain:

- Common errors
- Incorrect procedures
- Inappropriate operations with variables

Oklahoma Academic Standards 1.2 Sample Test Items:

Primary Process Standard: 8M1.5

Depth of Knowledge: 2

Correct Answer: B

What is the solution to this inequality?

$$2x + 6 < 4$$

- A** $x < 1$
- B** $x < -1$
- C** $x > 1$
- D** $x > -1$

Primary Process Standard: 8M1.3

Depth of Knowledge: 2

Correct Answer: C

Melissa has \$20 to buy bagels and juice for her class.

| | |
|-----------------|--------------------|
| box of bagels | \$6, including tax |
| carton of juice | \$2, including tax |

Melissa must buy 1 box of bagels and c cartons of juice. Which inequality can she use to find c , the maximum number of cartons of juice she can buy?

- A** $6c + 2 \leq 20$
- B** $6c + 2 \geq 20$
- C** $2c + 6 \leq 20$
- D** $2c + 6 \geq 20$

Primary Process Standard: 8M5.2

Depth of Knowledge: 2

Correct Answer: A

The picture of the balance shown models an inequality.

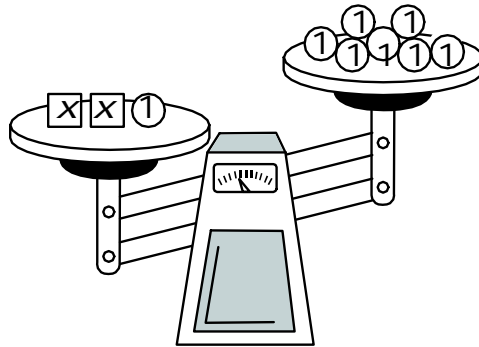

Which solution makes the inequality true?

- A $x > 3$
- B $x < 3$
- C $x = 6$
- D $x < 6$

Primary Process Standard: 8M1.6

Depth of Knowledge: 2

Correct Answer: D

Which graph represents the solution set for this inequality?

$$5n + 2 \leq 12$$

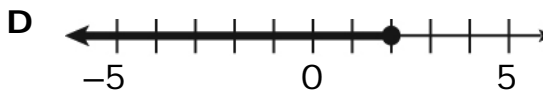
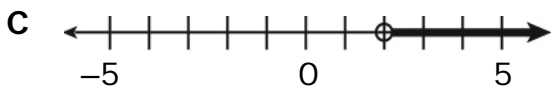
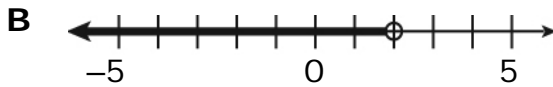
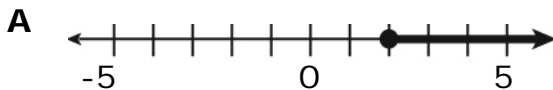

Primary Process Standard: 8M5.3

Depth of Knowledge: 3

Correct Answer: D

Jason was asked to graph the inequality $x \leq 4$ on a number line. He chose the correct endpoint and shaded the endpoint correctly but shaded the number line in the opposite direction. Which inequality did Jason graph?

A $x \leq -4$

B $x > -4$

C $x < 4$

D $x \geq 4$

OAS Standard:

Standard 2: Number Sense and Operation—The student will use numbers and number relationships to solve a variety of problems.

OAS Objective:

1. Number Sense: Represent and interpret large numbers and numbers less than one in exponential and scientific notation.

Item Specifications:Emphasis:

Demonstrate an understanding of how exponents are utilized in representing numbers with extreme quantities.

Stimulus Attributes:

Test items may include illustrations of the following: calculator displays, tables, graphs, and charts.

Format:

- Demonstrate an understanding of the magnitude of very large and very small numbers and the role of scientific and exponential notation in the representation of these numbers

Content Limits:

- Limit mathematical and real-life contexts to age-appropriate situations

Primary Process Standards:

Process Standard 1: Problem Solving

Process Standard 2: Communication

Process Standard 5: Representation

Distractor Domain:

- Computational errors
- Incorrect use of rules or properties

Oklahoma Academic Standards 2.1 Sample Test Items:

Primary Process Standard: 8M5.3

Depth of Knowledge: 1

Correct Answer: B

Astronomers estimate the internal temperature of the sun to be 15,000,000 degrees Kelvin. What is 15,000,000 written in scientific notation?

- A** 1.5×10^8
- B** 1.5×10^7
- C** 1.5×10^6
- D** 1.5×10^5

Primary Process Standard: 8M5.1

Depth of Knowledge: 2

Correct Answer: B

The table shows the masses of four planets.

Planets by Mass

| Planet | Mass (kg) |
|---------|-----------------------|
| Jupiter | 1.9×10^{27} |
| Mercury | 3.3×10^{23} |
| Earth | 5.98×10^{24} |
| Neptune | 1.02×10^{26} |

Which lists these planets in order from least to greatest mass?

- A Jupiter, Neptune, Earth, Mercury
- B Mercury, Earth, Neptune, Jupiter
- C Neptune, Jupiter, Mercury, Earth
- D Mercury, Neptune, Earth, Jupiter

Primary Process Standard: 8M2.1

Depth of Knowledge: 3

Correct Answer: C

Which number shows 92×10^4 written in correct scientific notation?

A 9.2×10^3

B 9.2×10^4

C 9.2×10^5

D 9.2×10^6

OAS Standard:

Standard 2: Number Sense and Operation—The student will use numbers and number relationships to solve a variety of problems.

OAS Objective:

2. Number Operations

- a. Use the rules of exponents, including integer exponents, to solve problems (e.g., $7^2 \cdot 7^3 = 7^5$, $3^{-10} \cdot 3^8 = 3^{-2}$).

Item Specifications:Emphasis:

Demonstrate an understanding of how exponents are utilized in representing and applying operations to all numbers, especially numbers with extreme quantities.

Stimulus Attributes:

Test items may include illustrations of the following: calculator displays, tables, graphs, and charts.

Format:

- Use the rules of exponents in mathematical and real-life contexts

Content Limits:

- Limit mathematical and real-life contexts to age-appropriate situations
- Limit to no more than two operations on exponential or scientific numbers
- Limit to integer exponents with the same base

Primary Process Standards:

Process Standard 1: Problem Solving

Process Standard 2: Communication

Process Standard 5: Representation

Distractor Domain:

- Computational errors
- Incorrect use of rules or properties

Oklahoma Academic Standards 2.2a Sample Test Items:

Primary Process Standard: 8M1.4

Depth of Knowledge: 1

Correct Answer: B

What is the simplified form of $\frac{a^8}{a^2}$ when $a \neq 0$?

- A a^{10}
- B a^6
- C $2a^4$
- D $2a^{10}$

Primary Process Standard: 8M2.1

Depth of Knowledge: 2

Correct Answer: B

What is the value of $3^3 \cdot 3^2$?

- A 729
- B 243
- C 81
- D 54

Primary Process Standard: 8M2.1

Depth of Knowledge: 2

Correct Answer: B

What is the value of $(5^2)^3$?

A 5^5

B 5^6

C 5^8

D 5^{23}

Primary Process Standard: 8M4.2

Depth of Knowledge: 3

Correct Answer: C

If $\frac{m^9}{m^6} = 8$, what is the value of $\frac{m^5}{m^2}$?

A 3

B 7

C 8

D 14

OAS Standard:

Standard 2: Number Sense and Operation—The student will use numbers and number relationships to solve a variety of problems.

OAS Objective:

2. Number Operations
 - b. Solve problems using scientific notation.

Item Specifications:Emphasis:

Demonstrate an understanding of how exponents are utilized in representing and applying operations to all numbers, especially numbers with extreme quantities.

Stimulus Attributes:

Test items may include illustrations of the following: calculator displays, tables, graphs, and charts.

Format:

- Demonstrate an understanding of the magnitude of very large and very small numbers and the role of scientific and exponential notation in the representation of these numbers
- Use the rules of exponents in mathematical and real-life contexts
- Demonstrate the concepts of positive and negative exponents using patterns

Content Limits:

- Limit mathematical and real-life contexts to age-appropriate situations
- Limit to no more than two operations on exponential or scientific numbers
- Limit to integer exponents with the same base

Primary Process Standards:

Process Standard 1: Problem Solving

Process Standard 2: Communication

Process Standard 5: Representation

Distractor Domain:

- Computational errors
- Incorrect use of rules or properties

Oklahoma Academic Standards 2.2b Sample Test Items:

Primary Process Standard: 8M1.4

Depth of Knowledge: 2

Correct Answer: D

Light travels at a speed of 299,792,458 meters per second (m/s). Which is closest in value to the speed of light?

- A** 2.9×10^6 m/s
- B** 2.9×10^8 m/s
- C** 3.0×10^6 m/s
- D** 3.0×10^8 m/s

Primary Process Standard: 8M2.1

Depth of Knowledge: 2

Correct Answer: C

Which expression is a simplified form of the product shown?

$$(3 \times 10^2)(4 \times 10^3)$$

- A** 1.2×10^5
- B** 7×10^5
- C** 1.2×10^6
- D** 7×10^6

Primary Process Standard: 8M1.4

Depth of Knowledge: 3

Correct Answer: C

Neptune is about 2.8×10^9 miles from the Sun. Earth is about 9.3×10^7 miles from the Sun. Which estimate best describes the quotient shown?

$$\frac{2.8 \times 10^9}{9.3 \times 10^7}$$

- A between 0 and 2
- B between 2 and 15
- C between 15 and 45
- D between 45 and 450

Primary Process Standard: 8M1.5

Depth of Knowledge: 3

Correct Answer: C

Which of these is equivalent to this expression?

$$(2.5 \times 10^2) + (4 \times 10^4)$$

- A 650
- B 4,250
- C 40,250
- D 65,000

OAS Standard:

Standard 2: Number Sense and Operation—The student will use numbers and number relationships to solve a variety of problems.

OAS Objective:

2. Number Operations
 - c. Simplify numerical expressions with rational numbers, exponents, and parentheses using order of operations.

Item Specifications:Emphasis:

Apply operations and the use of exponents and parentheses to rational numbers.

Stimulus Attributes:

Test items may include illustrations of the following: number lines and other diagrams and pictures.

Format:

- Use the basic operations on rational numbers in mathematical and real-life contexts

Content Limits:

- Limit mathematical and real-life contexts to age-appropriate situations
- Limit decimals to ten-thousandths
- Limit computations involving fractions to halves, thirds, fourths, fifths, sixths, eighths, tenths, and twelfths

Primary Process Standards:

Process Standard 1: Problem Solving

Process Standard 2: Communication

Process Standard 4: Connections

Process Standard 5: Representation

Distractor Domain:

- Computational errors
- Performing operations in wrong order

Oklahoma Academic Standards 2.2c Sample Test Item:

Primary Process Standard: 8M1.5

Depth of Knowledge: 2

Correct Answer: A

$$24 - 2(1 + 3^2)$$

What is the value of this expression?

- A** 4
- B** 10
- C** 31
- D** 220

OAS Standard:

Standard 3: Geometry—The student will use geometric properties to solve problems in a variety of contexts.

OAS Objective:

1. Construct models, sketch (from different perspectives), and classify solid figures such as rectangular solids, prisms, cones, cylinders, pyramids, and combined forms.

Item Specifications:Emphasis:

Classify solid figures, such as rectangular solids, prisms, cones, cylinders, pyramids, and combined forms.

Stimulus Attributes:

Test items may include illustrations of the following: rectangular solids, prisms, cones, cylinders, pyramids, spheres, and combined forms.

Format:

Classify and describe relationships of three-dimensional objects using their defining properties.

Content Limits:

Limit combined forms to no more than two three-dimensional solids.

Primary Process Standards:

Process Standard 2: Communication

Process Standard 3: Reasoning

Process Standard 5: Representation

Distractor Domain:

Common errors

Oklahoma Academic Standards 3.1 Sample Test Items:

Primary Process Standard: 8M2.3

Depth of Knowledge: 1

Correct Answer: B

Which of these is a prism?

- A** cone
- B** cube
- C** cylinder
- D** sphere

Primary Process Standard: 8M2.1

Depth of Knowledge: 2

Correct Answer: B

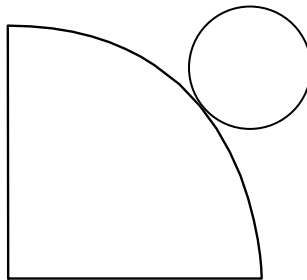
A net for a solid is shown.**Which geometric solid can be formed by folding this net?**

- A** cube
- B** cone
- C** cylinder
- D** sphere

Primary Process Standard: 8M3.1

Depth of Knowledge: 2

Correct Answer: B

Which two-dimensional pattern can be folded to make a triangular prism?

A

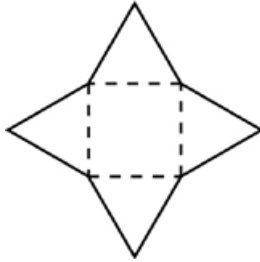

B

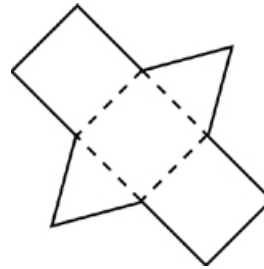

C

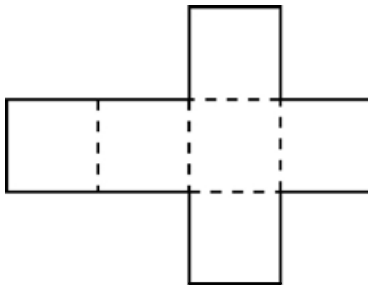

D

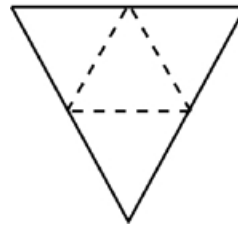

Primary Process Standard: 8M5.4

Depth of Knowledge: 2

Correct Answer: A

The drawing represents a 3-dimensional figure.

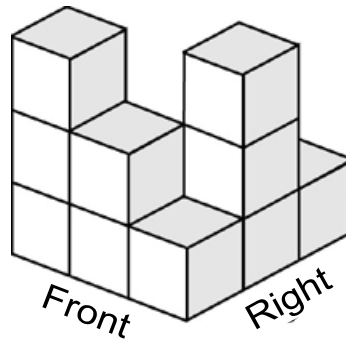

Which of these could represent the front and right views of the figure?

A

| | |
|-------|-------|
| Front | Right |
| | |

B

| | |
|-------|-------|
| Front | Right |
| | |

C

| | |
|-------|-------|
| Front | Right |
| | |

D

| | |
|-------|-------|
| Front | Right |
| | |

Primary Process Standard: 8M2.1

Depth of Knowledge: 3

Correct Answer: D

The drawing represents a 3-dimensional figure.

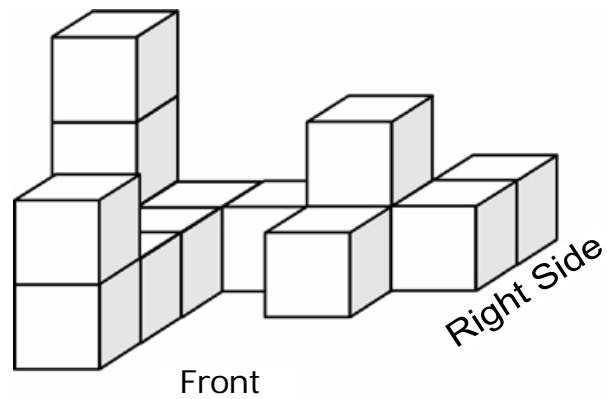

Which of these represents the view from the left side of the figure?

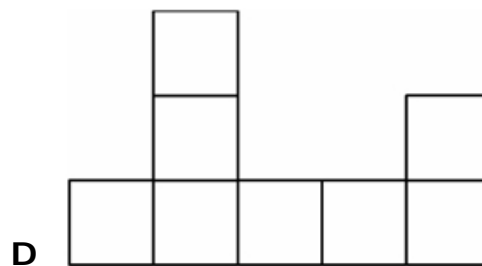
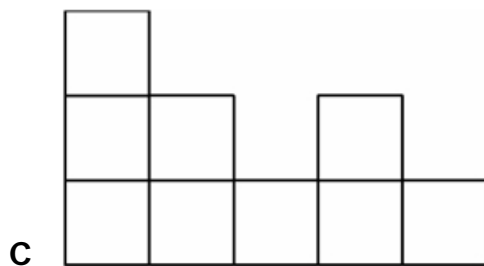
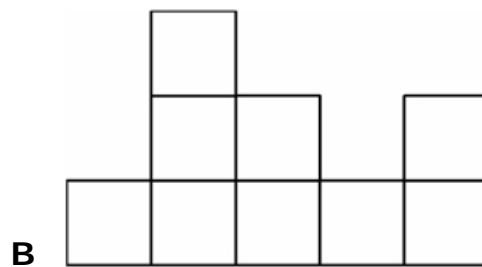
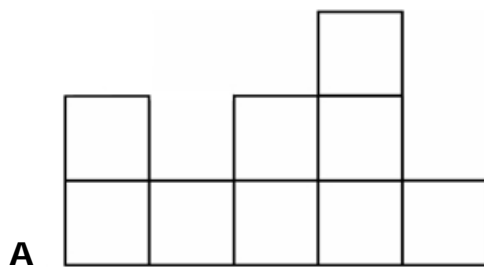

OAS Standard:

Standard 3: Geometry—The student will use geometric properties to solve problems in a variety of contexts.

OAS Objective:

2. Develop the Pythagorean Theorem and apply the formula to find the length of line segments, the shortest distance between two points on a graph, and the length of an unknown side of a right triangle.

Item Specifications:Emphasis:

Demonstrate the ability to apply the Pythagorean Theorem to find lengths of sides and line segments in various contexts.

Stimulus Attributes:

Plane geometric figures and word problems.

Format:

Identify situations in which the use of the Pythagorean Theorem is appropriate in finding missing lengths of the sides of geometric figures and line segments given in various contexts through age appropriate word problems.

Content Limits:

- Limit geometric figures to right triangles, rectangles, or combined forms which include triangles, rectangles, or circles
- Limit final answer choices to whole numbers (after rounding) and radicals (simplification not needed, except for perfect squares)
- Limit real-life and mathematical contexts to age appropriate situations

Primary Process Standards:

Process Standard 1: Problem Solving

Process Standard 3: Reasoning

Process Standard 4: Connections

Process Standard 5: Representation

Distractor Domain:

- Computational errors
- Incorrect procedures

Oklahoma Academic Standards 3.2 Sample Test Items:

Primary Process Standard: 8M1.6

Depth of Knowledge: 1

Correct answer: A

What is the length of the side that is not labeled in this right triangle?

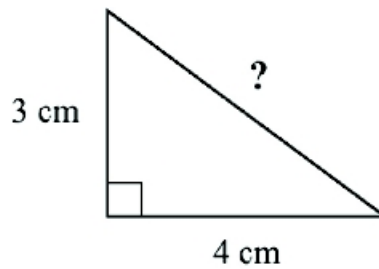

- A 5 cm
- B 6 cm
- C 7 cm
- D 8 cm

Primary Process Standard: 8M5.2

Depth of Knowledge: 2

Correct Answer: C

What is the length of side h in this triangle?

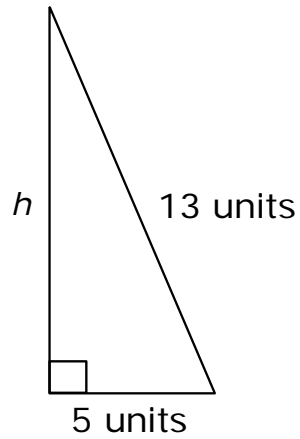

$$a^2 + b^2 = c^2$$

- A 18 units
- B 14 units
- C 12 units
- D 8 units

Primary Process Standard: 8M1.1

Depth of Knowledge: 2

Correct Answer: C

This rectangle has a length of 20 cm and a diagonal measure of 25 cm.

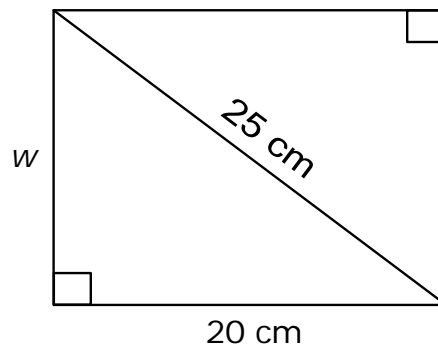

What is w , the width of the rectangle?

$$a^2 + b^2 = c^2$$

- A 5 cm
- B 11 cm
- C 15 cm
- D 45 cm

Primary Process Standard: 8M4.1

Depth of Knowledge: 3

Correct Answer: B

The catcher in a baseball game threw the baseball from home plate to second base.

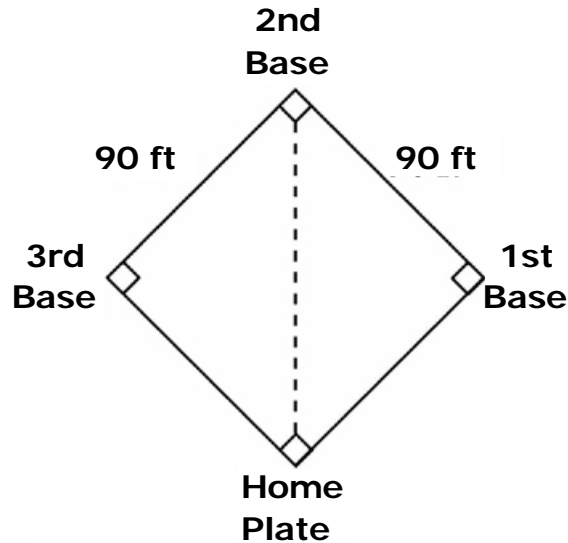

Which is closest to the distance the ball was thrown?

$$a^2 + b^2 = c^2$$

- A 150 ft
- B 130 ft
- C 110 ft
- D 90 ft

Primary Process Standard: 8M4.2

Depth of Knowledge: 3

Correct Answer: B

The figure shows some of the dimensions of an isosceles trapezoid.

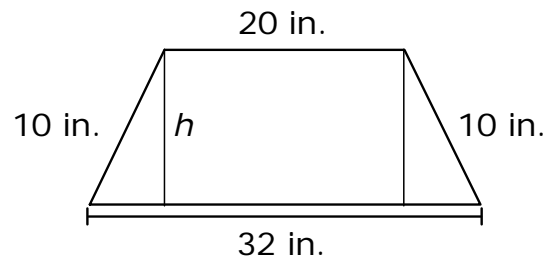

What is h , the height of the trapezoid?

$$a^2 + b^2 = c^2$$

- A 6 in.
- B 8 in.
- C 12 in.
- D 13 in.

Primary Process Standard: 8M1.6

Depth of Knowledge: 3

Correct Answer: A

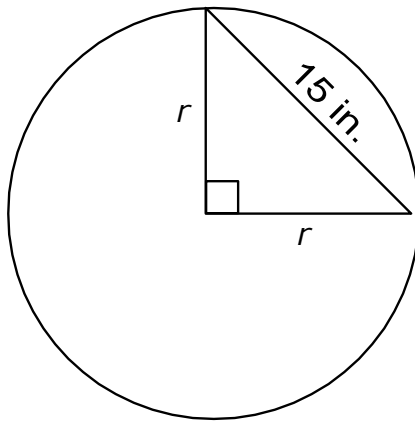
What is the radius, r , of this circle?

$$a^2 + b^2 = c^2$$

- A** $\sqrt{\frac{225}{2}}$ in.
- B** $\sqrt{\frac{15}{2}}$ in.
- C** $\left(\frac{225}{2}\right)^2$ in.
- D** $\left(\frac{15}{2}\right)^2$ in.

OAS Standard:

Standard 4: Measurement—The student will use measurement to solve problems in a variety of contexts.

OAS Objective:

1. Develop and apply formulas to find the surface area and volume of rectangular prisms, triangular prisms, and cylinders (in terms of π).

Item Specifications:Emphasis:

Apply the concepts of surface area and volume to real-world settings.

Stimulus Attributes:

Test items may include illustrations of the following: rectangular prisms and other geometric solids.

Format:

- Determine the surface area of right rectangular prisms
- Identify and apply strategies for determining volume and surface area of other three-dimensional solids

Content Limits:

Limit solids to rectangular prisms, triangular prisms, and cylinders

Primary Process Standards:

Process Standard 1: Problem Solving

Process Standard 2: Communication

Process Standard 3: Reasoning

Process Standard 4: Connections

Process Standard 5: Representation

Distractor Domain:

- Computational errors
- Incorrect procedures
- Interchange volume and surface area

Oklahoma Academic Standards 4.1 Sample Test Items:

Primary Process Standard: 8M1.1

Depth of Knowledge: 2

Correct Answer: D

The length of each edge of this cube is 4 centimeters (cm).

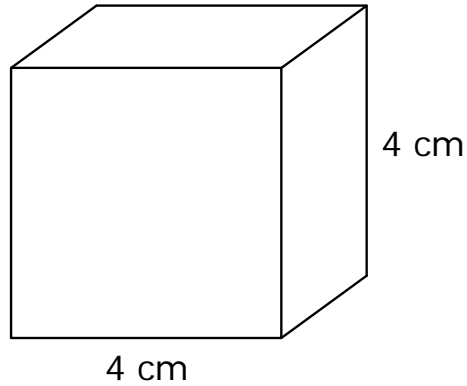

What is the surface area of the cube in square centimeters (cm²)?

$$SA_{\text{cube}} = 6s^2$$

- A 32 cm²
- B 48 cm²
- C 64 cm²
- D 96 cm²

Primary Process Standard: 8M5.4

Depth of Knowledge: 2

Correct Answer: D

A box is 10 inches long, 3 inches wide, and 4 inches high. What is the surface area, in square inches (sq in.), of the closed box?

$$SA_{\text{rectangular prism}} = 2(lw + lh + wh)$$

- A 120 sq in.
- B 134 sq in.
- C 140 sq in.
- D 164 sq in.

Primary Process Standard: 8M4.1

Depth of Knowledge: 2

Correct Answer: B

A cylinder has a diameter of 10 feet (ft). The height of the cylinder is 4 ft. Which is closest to the surface area of the cylinder?

$$SA_{\text{cylinder}} = 2\pi rh + 2\pi r^2$$

- A 180 sq ft
- B 280 sq ft
- C 380 sq ft
- D 880 sq ft

Primary Process Standard: 8M3.3

Depth of Knowledge: 2

Correct Answer: A

Patrick has two cylindrical cups with the dimensions shown.

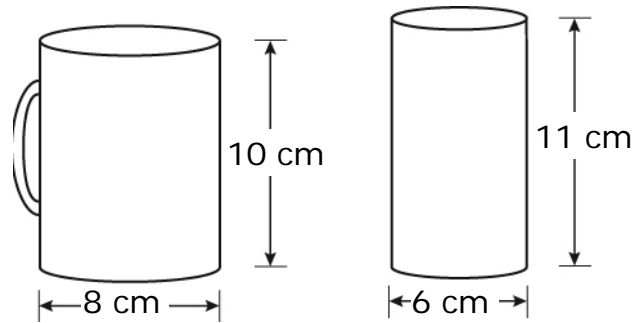

What is the difference in the volumes of the two cylinders in cubic centimeters (cm^3)?

$$V_{\text{cylinder}} = \pi r^2 h$$

- A $61\pi \text{ cm}^3$
- B $124\pi \text{ cm}^3$
- C $244\pi \text{ cm}^3$
- D $259\pi \text{ cm}^3$

OAS Standard:

Standard 4: Measurement—The student will use measurement to solve problems in a variety of contexts.

OAS Objective:

2. Apply knowledge of ratio and proportion to solve relationships between similar geometric figures.

Item Specifications:Emphasis:

Solve problems involving scale factors of geometric figures using ratio and proportion.

Stimulus Attributes:

Test items may include illustrations of the following: maps, two- and three-dimensional figures, and scale drawings.

Format:

Apply the concepts of similarity to geometric and real-world settings.

Content Limits:

Limit to ratios of length.

Primary Process Standards:

Process Standard 1: Problem Solving

Process Standard 4: Connections

Process Standard 5: Representation

Distractor Domain:

- Common errors
- Incorrect procedures or use of proportions

Oklahoma Academic Standards 4.2 Sample Test Items:

Primary Process Standard: 8M3.4

Depth of Knowledge: 2

Correct Answer: B

The diagram shows the dimensions of a cylinder.

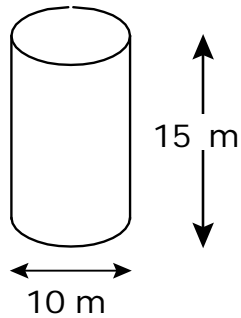

Which of these could be the dimensions, in meters, of a different cylinder that is similar to the one shown in the diagram?

- A diameter = 6 m, height = 8 m
- B diameter = 6 m, height = 9 m
- C diameter = 9 m, height = 12 m
- D diameter = 9 m, height = 15 m

Primary Process Standard: 8M4.2

Depth of Knowledge: 2

Correct Answer: D

The figure shows $\triangle ABC$ with \overline{ED} perpendicular to \overline{AC} . $\triangle ABC$ is similar to $\triangle DEC$.

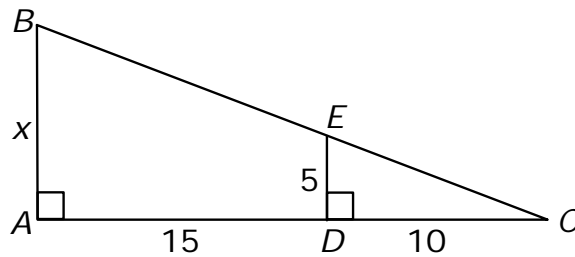

Which proportion can be used to find x , the length of \overline{AB} ?

- A** $\frac{25}{x} = \frac{5}{10}$
- B** $\frac{5}{10} = \frac{15}{x}$
- C** $\frac{10}{15} = \frac{25}{x}$
- D** $\frac{10}{25} = \frac{5}{x}$

Primary Process Standard: 8M4.1

Depth of Knowledge: 2

Correct Answer: C

Albert has a rectangular poster that is 1 foot in length and 8 inches in width. He reduced the dimensions of the poster proportionally so that the new poster has a width of 3 inches (in.). What is the length of the new poster?

- A** 9.0 in.
- B** 7.5 in.
- C** 4.5 in.
- D** 2.6 in.

Primary Process Standard: 8M1.5

Depth of Knowledge: 3

Correct Answer: B

Rectangle $ABDE$ is similar to rectangle $BCFA$.

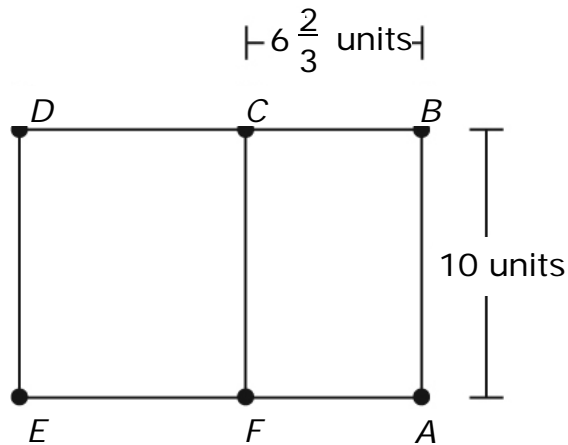

What is the length of \overline{EA} ?

- A $16\frac{2}{3}$
- B 15 units
- C 5 units
- D $3\frac{1}{3}$ units

OAS Standard:

Standard 4: Measurement—The student will use measurement to solve problems in a variety of contexts.

OAS Objective:

3. Find the area of a “region of a region” for simple composite figures and the area of cross sections of regular geometric solids (e.g., area of a rectangular picture frame).

Item Specifications:Emphasis:

Identify, select, and apply appropriate formulas to find area of composite shapes and cross sections.

Stimulus Attributes:

Test items may include illustrations of two- and three-dimensional geometric figures.

Format:

- Select and apply appropriate formulas for mathematical and real-world situations
- Identify new formulas and apply combinations of formulas to determine the area of a “region of a region”

Content Limits:

- Limit composite shapes to those made up of squares, rectangles, triangles, and circles
- Limit multistep processes to no more than two steps for each component stage

Primary Process Standards:

Process Standard 1: Problem Solving

Process Standard 2: Communication

Process Standard 3: Reasoning

Process Standard 4: Connections

Process Standard 5: Representation

Distractor Domain:

- Common errors
- Use of inappropriate formulas
- Incorrect procedures

Oklahoma Academic Standards 4.3 Sample Test Items:

Primary Process Standard: 8M1.5

Depth of Knowledge: 2

Correct Answer: D

Juan cut the largest possible circle out of a 6-inch square as shown.

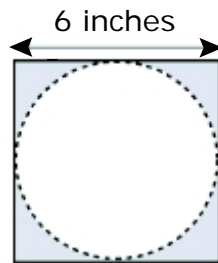

What is the area of the remaining shaded region of the square?

$$A_{\text{square}} = s^2$$

$$A_{\text{circle}} = \pi r^2$$

- A $(24 - 6\pi)$ square inches
- B $(24 - 9\pi)$ square inches
- C $(36 - 6\pi)$ square inches
- D $(36 - 9\pi)$ square inches

Primary Process Standard: 8M1.5

Depth of Knowledge: 2

Correct Answer: C

The diagram shows a walkway that goes all the way around a rectangular garden.

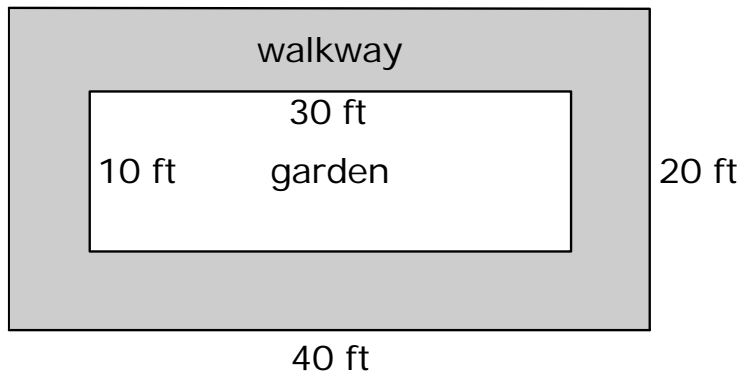

What is the area, in square feet (sq ft), of the walkway?

$$A = lw$$

- A 100 sq ft
- B 300 sq ft
- C 500 sq ft
- D 800 sq ft

Primary Process Standard: 8M1.5

Depth of Knowledge: 2

Correct Answer: A

The figure shown is made up of a rectangle and a semicircle.

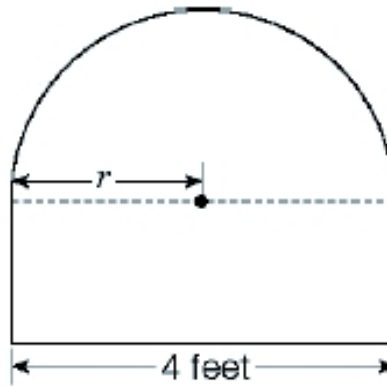

What is the area, in square feet, of the semicircle?

$$A_{\text{circle}} = \pi r^2$$

- A 2π square feet
- B 4π square feet
- C 8π square feet
- D 16π square feet

OAS Standard:

Standard 5: Data Analysis—The student will use data analysis, probability, and statistics to interpret data in a variety of contexts.

OAS Objective:

1. Data Analysis: Select, analyze and apply data displays in appropriate formats to draw conclusions and solve problems.

Item Specifications:Emphasis:

Select and apply appropriate formats in the presentation of collected data.

Stimulus Attributes:

Test items may include illustrations of the following: tables, frequency charts, line, bar, and circle graphs, pictographs, stem-and-leaf plots, scatter plots, and histograms.

Format:

- Identify appropriate formats for the display of data
- Read and interpret information from various representations of collected data

Content Limits:

Limit representations of data to tables, frequency charts, line graphs, bar graphs, line plots, pictographs, stem-and-leaf plots, scatter plots, histograms, and circle graphs.

Primary Process Standards:

Process Standard 1: Problem Solving

Process Standard 2: Communication

Process Standard 3: Reasoning

Process Standard 5: Representation

Distractor Domain:

- Common errors of interpretations of data
- Inappropriate formats for displays of data

Oklahoma Academic Standards 5.1 Sample Test Items:

Primary Process Standard: 8M2.1

Depth of Knowledge: 1

Correct Answer: B

Eighth graders were asked about their favorite night to watch TV. The table shows the results of the survey.

TV Viewing

| Night | Percent Favoring |
|-----------|------------------|
| Monday | 50% |
| Tuesday | 10% |
| Wednesday | 10% |
| Thursday | 25% |
| Friday | 5% |

Which graph shows the information from the table?

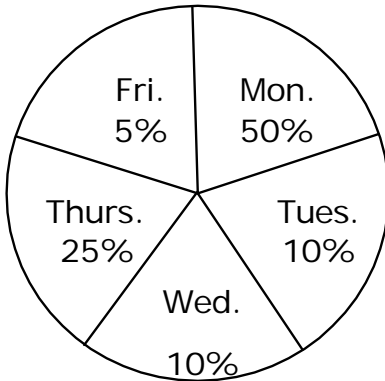
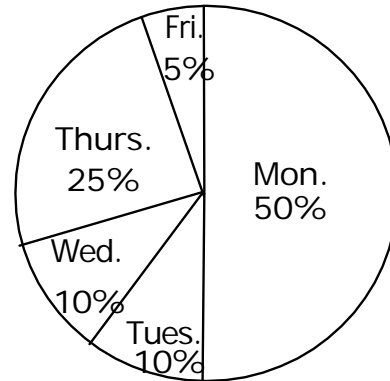
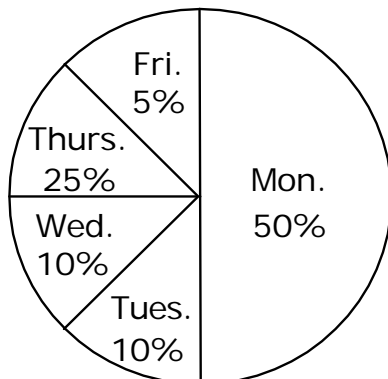
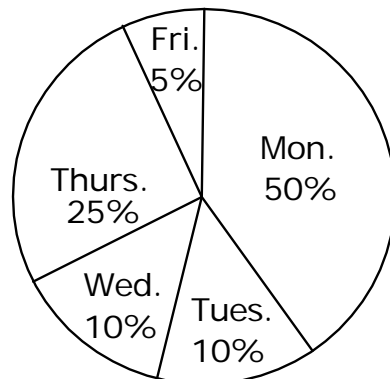
A TV Viewing**B TV Viewing****C TV Viewing****D TV Viewing**

Primary Process Standard: 8M5.1

Depth of Knowledge: 1

Correct Answer: D

Jill plans to conduct a survey to study the relationship between the number of hours her classmates watch television and their quiz scores. Which would be an appropriate way for Jill to display the survey data?

- A** stem-and-leaf plot
- B** line graph
- C** circle graph
- D** scatter plot

Primary Process Standard: 8M5.2

Depth of Knowledge: 2

Correct Answer: C

This line plot shows the number of goals scored by a soccer team during each game last season.

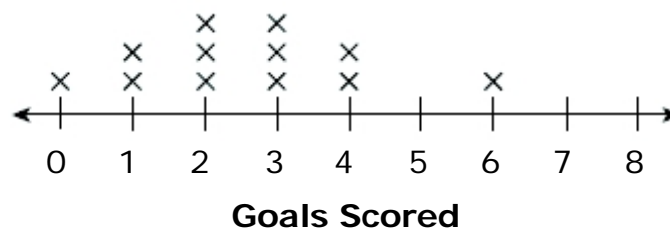

In how many games did the team score more than 1 goal?

- A** 4 games
- B** 7 games
- C** 9 games
- D** 12 games

Primary Process Standard: 8M5.4

Depth of Knowledge: 2

Correct Answer: C

The table shows the mean attendance for four different athletic events during the past year.

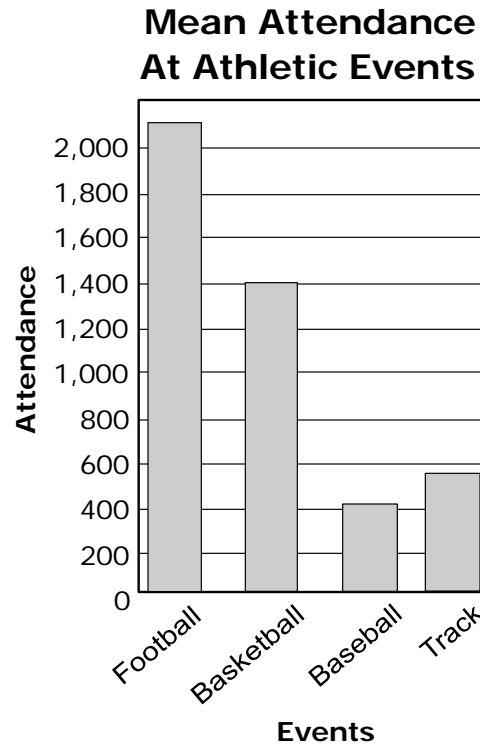

How much greater was the mean attendance for the football events than the track events?

- A 14
- B 15
- C 1,550
- D 14,500

Primary Process Standard: 8M2.1

Depth of Knowledge: 2

Correct Answer: C

Sylvia placed her test scores in this histogram.

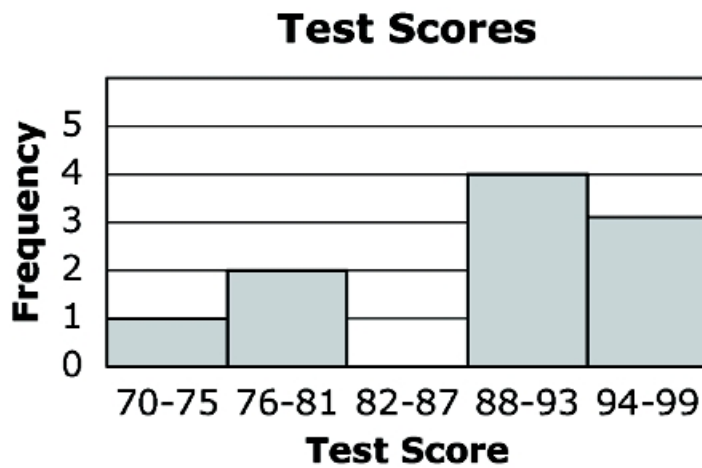

Which estimate could represent Sylvia's median test score?

- A 81
- B 85
- C 88
- D 94

Primary Process Standard: 8M5.2

Depth of Knowledge: 3

Correct Answer: C

An insurance salesman uses this graph to determine life insurance costs.

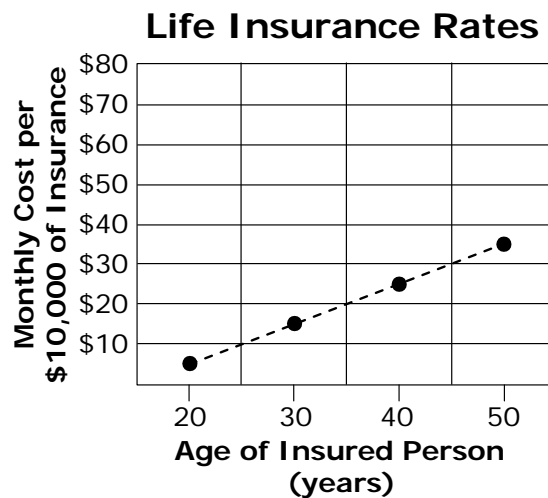

The y-axis shows the monthly cost for every \$10,000 of insurance purchased. Which is closest to the monthly cost for \$100,000 of life insurance for a person who is 30 years of age?

- A \$15
- B \$30
- C \$150
- D \$300

OAS Standard:

Standard 5: Data Analysis—The student will use data analysis, probability, and statistics to interpret data in a variety of contexts.

OAS Objective:

3. Central Tendency: Find the measures of central tendency (mean, median, mode, and range) of a set of data and understand why a specific measure provides the most useful information in a given context.

Item Specifications:Emphasis:

Demonstrate an understanding of mean, median, mode, and range.

Stimulus Attributes:

Test items may include illustrations of the following: charts, tables, graphs, and data sets.

Format:

- Identify why a specific measure provides the most useful information in a given context
- Analyze the appropriate use of the mean in comparison with other measures of central tendency

Content Limits:

Limit data sets to at most 20 data points.

Primary Process Standards:

Process Standard 2: Communication

Process Standard 3: Reasoning

Distractor Domain:

- Common errors
- Incorrect procedures
- Use of median or mode in place of mean

Oklahoma Academic Standards 5.3 Sample Test Items:

Primary Process Standard: 8M1.1

Depth of Knowledge: 1

Correct Answer: B

A student's last eight homework scores are listed.

75, 87, 0, 84, 74, 85, 74, 81

What is the median of these homework scores?

- A 70
- B 78
- C 80
- D 81

Primary Process Standard: 8M4.2

Depth of Knowledge: 2

Correct Answer: D

For which data set is the median greater than the mode?

- A 10, 7, 5, 3, 10
- B 26, 31, 28, 26, 22
- C 9, 0, 1, 9, 3
- D 16, 12, 21, 12, 14

Primary Process Standard: 8M2.1

Depth of Knowledge: 2

Correct Answer: A

Julian listed 8 players' scores from a golf tournament.

5, 0, -4, 6, 2, -3, 5, 3

What is the mean of these scores?

- A** 1.75
- B** 2
- C** 2.5
- D** 3