



1. Solicitation #: SW110

2. Solicitation Issue Date: 02/14/2013

3. Brief Description of Requirement:

Statewide Contract for School Buses.

Questions regarding this solicitation are to be emailed to the address below no later than Tuesday, March 5th, 2013.

4. Response Due Date¹: 04/04/2013

Time: 3:00 PM CST/CDT

5. Issued By and RETURN SEALED BID TO:

Personal or Common Carrier Delivery:

Office of Management and Enterprise Services
Central Purchasing Division
Will Rogers Building
2401 N. Lincoln Blvd, Suite 116,
Oklahoma City, OK 73105

U.S. Postal Delivery:

Office of Management and Enterprise Services
Central Purchasing Division
P.O. Box 528803,
Oklahoma City, Oklahoma 73152-8803

6. Solicitation Type (check one below):

- Invitation to Bid
 Request for Proposal
 Request for Quote

7. Requesting Agency: OMES/Central Purchasing Division

8. Contracting Officer:

Name: Laura Bybee
Phone: (405) 522-1037
Email: laura.bybee@omes.ok.gov



“Certification for Competitive Bid and Contract” **MUST** be submitted along with the response to the Solicitation.

1. **RE: Solicitation #** SW110

2. **Bidder General Information:**

FEI / SSN : _____ VEN ID: _____
Company Name: _____

3. **Bidder Contact Information:**

Address: _____
City: _____ State: _____ Zip Code: _____
Contact Name: _____
Contact Title: _____
Phone #: _____ FAX#: _____
Email: _____ Website: _____

4. **Oklahoma Sales Tax Permit¹:**

- YES – Permit #: _____
- NO – Exempt pursuant to Oklahoma Laws or Rules

5. **Registration with the Oklahoma Secretary of State:**

- YES - Filing Number: _____
- NO - Prior to the contract award, the successful bidder will be required to register with the Secretary of State or must attach a signed statement that provides specific details supporting the exemption the supplier is claiming (www.sos.ok.gov or 405-521-3911).

6. **Workers’ Compensation Insurance Coverage:**

Bidder is required to provide with the bid a certificate of insurance showing proof of compliance with the Oklahoma Workers’ Compensation Act.

- YES – include a certificate of insurance with the bid
- NO - attach a signed statement that provides specific details supporting the exemption you are claiming from the Workers’ Compensation Act (Note: Pursuant to Attorney General Opinion #07-8, the exemption from 85 O.S. 2011, § 311 applies only to employers who are natural persons, such as sole proprietors, and does not apply to employers who are entities created by law, including but not limited to corporations, partnerships and limited liability companies.)²

Authorized Signature Date

Printed Name Title

¹ For frequently asked questions concerning Oklahoma Sales Tax Permit, see <http://www.tax.ok.gov/faq/faqbussales.html>

² For frequently asked questions concerning workers’ compensation insurance, see <http://www.ok.gov/oid/faqs.html#c221>



**State of Oklahoma
Office of Management and Enterprise Services
Central Purchasing Division**

**Certification for Competitive
Bid and/or Contract
(Non-Collusion Certification)**

NOTE: A certification shall be included with any competitive bid and/or contract exceeding \$5,000.00 submitted to the State for goods or services.

Solicitation or Purchase Order #: SW110

Supplier Legal Name: _____

SECTION I [74 O.S. § 85.22]:

A. For purposes of competitive bid,

1. I am the duly authorized agent of the above named bidder submitting the competitive bid herewith, for the purpose of certifying the facts pertaining to the existence of collusion among bidders and between bidders and state officials or employees, as well as facts pertaining to the giving or offering of things of value to government personnel in return for special consideration in the letting of any contract pursuant to said bid;
2. I am fully aware of the facts and circumstances surrounding the making of the bid to which this statement is attached and have been personally and directly involved in the proceedings leading to the submission of such bid; and
3. Neither the bidder nor anyone subject to the bidder's direction or control has been a party:
 - a. to any collusion among bidders in restraint of freedom of competition by agreement to bid at a fixed price or to refrain from bidding,
 - b. to any collusion with any state official or employee as to quantity, quality or price in the prospective contract, or as to any other terms of such prospective contract, nor
 - c. in any discussions between bidders and any state official concerning exchange of money or other thing of value for special consideration in the letting of a contract.

B. I certify, if awarded the contract, whether competitively bid or not, neither the contractor nor anyone subject to the contractor's direction or control has paid, given or donated or agreed to pay, give or donate to any officer or employee of the State of Oklahoma any money or other thing of value, either directly or indirectly, in procuring this contract herein.

SECTION II [74 O.S. § 85.42]:

For the purpose of a contract for services, the supplier also certifies that no person who has been involved in any manner in the development of this contract while employed by the State of Oklahoma shall be employed by the supplier to fulfill any of the services provided for under said contract.

The undersigned, duly authorized agent for the above named supplier, by signing below acknowledges this certification statement is executed for the purposes of:

- the competitive bid attached herewith and contract, if awarded to said supplier;
OR
 the contract attached herewith, which was not competitively bid and awarded by the agency pursuant to applicable Oklahoma statutes.

Supplier Authorized Signature

Certified This Date

Printed Name

Title

Phone Number

Email

Fax Number

TABLE OF CONTENTS

A GENERAL PROVISIONS.....5

B. SPECIAL PROVISIONS9

C. SOLICITATION SPECIFICATIONS.....12

D. EVALUATION42

E. INSTRUCTIONS TO SUPPLIER42

F. CHECKLIST42

G. OTHER42

H. PRICE AND COST56



**State of Oklahoma
Department of Central Services
Central Purchasing**

**CP Solicitation
General Provisions**

1. DEFINITIONS

- 1.1. "Acquisition" means items, products, materials, supplies, services and equipment a state agency acquires by purchase, lease purchase, lease with option to purchase, or rental pursuant to the Oklahoma Central Purchasing Act;
- 1.2. "Bid" means an offer in the form of a bid, proposal or quote a bidder submits in response to a solicitation;
- 1.3. "Bidder" means an individual or business entity that submits a bid in response to solicitation;
- 1.4. "Solicitation" means a request or invitation by the State Purchasing Director or a state agency for a supplier to submit a priced offer to sell acquisitions to the state. A solicitation may be an invitation to bid, request for proposal, or a request for quotation; and
- 1.5. "Supplier" means an individual or business entity that sells or desires to sell acquisitions to state agencies.

2. BID SUBMISSION

- 2.1. Submitted bids shall be in strict conformity with the instructions to bidders and shall be submitted with a completed "Responding Bidder Information", DCS-FORM-CP-076, and any other forms required by the solicitation.
- 2.2. Bids shall be submitted to the Central Purchasing Division in a single envelope, package, or container and shall be sealed. The name and address of the bidder shall be inserted in the upper left corner of the single envelope, package, or container. SOLICITATION NUMBER AND SOLICITATION RESPONSE DUE DATE AND TIME MUST APPEAR ON THE FACE OF THE SINGLE ENVELOPE, PACKAGE, OR CONTAINER.
- 2.3. The required certification statement, "Certification for Competitive Bid and/or Contract (Non-Collusion Certification)", DCS-FORM-CP-004, must be made out in the name of the bidder and must be properly executed by an authorized person, with full knowledge and acceptance of all its provisions.
- 2.4. All bids shall be legibly written or typed. Any corrections to bids shall be initialed. Penciled bids and penciled corrections shall NOT be accepted and will be rejected as non-responsive.
- 2.5. All bids submitted shall be subject to the Oklahoma Central Purchasing Act, Central Purchasing Rules, and other statutory regulations as applicable, these General Provisions, any Special Provisions, solicitation specifications, required certification statement, and all other terms and conditions listed or attached herein—all of which are made part of this solicitation.

3. SOLICITATION AMENDMENTS

- 3.1. If an "Amendment of Solicitation", DCS-FORM-CP-011, is issued, the bidder shall acknowledge receipt of any/all amendment(s) to solicitations by signing and returning the solicitation amendment(s). Amendment acknowledgement(s) may be submitted with the bid or may be forwarded separately. If forwarded separately, amendment acknowledgement(s) must contain the solicitation number and response due date and time on the front of the envelope. The Central Purchasing Division must receive the amendment acknowledgement(s) by the response due date and time specified for receipt of bids for the bid to be deemed responsive. Failure to acknowledge solicitation amendments may be grounds for rejection.
- 3.2. No oral statement of any person shall modify or otherwise affect the terms, conditions, or specifications stated in the solicitation. All amendments to the solicitation shall be made in writing by the Central Purchasing Division.
- 3.3. It is the Bidder's responsibility to check the DCS/Central Purchasing Division website frequently for any possible amendments that may be issued. The Central Purchasing Division is not responsible for a bidder's failure to download any amendment documents required to complete a solicitation.

4. BID CHANGE

If the bidder needs to change a bid prior to the solicitation response due date, a new bid shall be submitted to the Central Purchasing Division with the following statement "This bid supersedes the bid previously submitted" in a single envelope, package, or container and shall be sealed. The name and address of the bidder shall be inserted in the upper left corner of the single envelope, package, or container. SOLICITATION NUMBER AND SOLICITATION RESPONSE DUE DATE AND TIME MUST APPEAR ON THE FACE OF THE SINGLE ENVELOPE, PACKAGE, OR CONTAINER.

5. CERTIFICATION REGARDING DEBARMENT, SUSPENSION, AND OTHER RESPONSIBILITY MATTERS

By submitting a response to this solicitation:

- 5.1. The prospective primary participant and any subcontractor certifies to the best of their knowledge and belief, that they and their principals or participants:
 - 5.1.1. Are not presently debarred, suspended, proposed for debarment, declared ineligible, or voluntarily excluded by any Federal, State or local department or agency;

- 5.1.2. Have not within a three-year period preceding this proposal been convicted of or had a civil judgment rendered against them for commission of fraud or a criminal offense in connection with obtaining, attempting to obtain, or performing a public (Federal, State or local) contract; or for violation of Federal or State antitrust statutes or commission of embezzlement, theft, forgery, bribery, falsification or destruction of records, making false statements, or receiving stolen property;
- 5.1.3. Are not presently indicted for or otherwise criminally or civilly charged by a governmental entity (Federal, State or local) with commission of any of the offenses enumerated in paragraph A.5.1.2. of this certification; and
- 5.1.4. Have not within a three-year period preceding this application/proposal had one or more public (Federal, State or local) contracts terminated for cause or default.

5.2. Where the prospective primary participant is unable to certify to any of the statements in this certification, such prospective participant shall attach an explanation to its solicitation response.

6. BID OPENING

Sealed bids shall be opened by the Central Purchasing Division at the Department of Central Services, Will Rogers Building, 2401 N. Lincoln Blvd. First Floor, Suite 116, Oklahoma City, Oklahoma, 73105 at the time and date specified in the solicitation as Response Due Date and Time.

7. BIDS SUBJECT TO PUBLIC DISCLOSURE

Unless otherwise specified in the Oklahoma Open Records Act, Central Purchasing Act, or other applicable law, documents and information a bidder submits as part of or in connection with a bid are public records and subject to disclosure. Bidders claiming any portion of their bid as proprietary or confidential must specifically identify what documents or portions of documents they consider confidential and identify applicable law supporting their claim of confidentiality. The State Purchasing Director shall make the final decision as to whether the documentation or information is confidential pursuant to 74 O.S. §85.10.

8. LATE BIDS

Bids received by the Central Purchasing Division after the response due date and time shall be deemed non-responsive and shall NOT be considered for any resultant award.

9. LEGAL CONTRACT

- 9.1. Submitted bids are rendered as a legal offer and any bid, when accepted by the Central Purchasing Division, shall constitute a contract.
- 9.2. The Contract resulting from this solicitation will consist of the following documents in order of preference: Contract award documents, including but not limited to the Purchase Order, Contract Modifications, required certification statement, affidavit, and change orders; the solicitation including any amendments; and the successful bid to the extent that the bid does not conflict with the requirements of the Contract award documents or solicitation or applicable law. In the event there is a conflict between any of the preceding documents, the Contract award documents prevail over the solicitation, and both the Contract award documents and the solicitation shall prevail over the successful bid.
- 9.3. Any contract(s) awarded pursuant to the solicitation shall be legibly written or typed.

10. PRICING

- 10.1. Bids shall remain firm for a minimum of sixty (60) days from the solicitation closing date.
- 10.2. Bidders guarantee unit prices to be correct.
- 10.3. In accordance with 74 O.S. §85.40, ALL travel expenses to be incurred by the supplier in performance of the Contract shall be included in the total bid price/contract amount.

11. MANUFACTURERS' NAME AND APPROVED EQUIVALENTS

Unless otherwise specified in the solicitation, manufacturers' names, brand names, information and/or catalog numbers listed in a specification are for information and not intended to limit competition. Bidder may offer any brand for which they are an authorized representative, which meets or exceeds the specification for any item(s). However, if bids are based on equivalent products, indicate on the bid form the manufacturer's name and number. Bidder shall submit sketches, descriptive literature, and/or complete specifications with their bid. Reference to literature submitted with a previous bid will not satisfy this provision. The bidder shall also explain in detail the reason(s) why the proposed equivalent will meet the specifications and not be considered an exception thereto. Bids that do not comply with these requirements are subject to rejection.

12. CLARIFICATION OF SOLICITATION

Clarification pertaining to the contents of this solicitation shall be directed in writing to the Central Purchasing Contracting Officer specified in the solicitation.

13. REJECTION OF BID

The State reserves the right to reject any bids that do not comply with the requirements and specifications of the solicitation. A bid may be rejected when the bidder imposes terms or conditions that would modify requirements of the solicitation or limit the bidder's liability to the State. Other possible reasons for rejection of bids are listed in OAC 580:15-4-11.

14. AWARD OF CONTRACT

- 14.1. The State Purchasing Director may award the Contract to more than one bidder by awarding the Contract(s) by item or groups of items, or may award the Contract on an ALL OR NONE basis, whichever is deemed by the State Purchasing Director to be in the best interest of the State of Oklahoma.
- 14.2. Contract awards will be made to the lowest and best bidder(s) unless the solicitation specifies that best value criteria is being used.
- 14.3. In order to receive an award or payments from the State of Oklahoma, suppliers must be registered. The vendor registration process can be completed electronically through the DCS website at the following link:
<https://www.ok.gov/dcs/vendors/index.php>.

15. CONTRACT MODIFICATION

- 15.1. The Contract is issued under the authority of the State Purchasing Director who signs the Contract. The Contract may be modified only through a written Contract Modification, signed by the State Purchasing Director.
- 15.2. Any change to the Contract, including the addition of work or materials, the revision of payment terms, or the substitution of work or materials, directed by a person who is not specifically authorized by the Central Purchasing Division in writing, or made unilaterally by the Supplier, is a breach of the Contract. Unless otherwise specified by applicable law or rules, such changes, including unauthorized written Contract Modifications, shall be void and without effect, and the Supplier shall not be entitled to any claim under this Contract based on those changes. No oral statement of any person shall modify or otherwise affect the terms, conditions, or specifications stated in the resultant Contract.

16. DELIVERY, INSPECTION AND ACCEPTANCE

- 16.1. Unless otherwise specified in the solicitation or awarding documents, all deliveries shall be F.O.B. Destination. The bidder(s) awarded the Contract shall prepay all packaging, handling, shipping and delivery charges and firm prices quoted in the bid shall include all such charges. All products and/or services to be delivered pursuant to the Contract shall be subject to final inspection and acceptance by the State at destination. "Destination" shall mean delivered to the receiving dock or other point specified in the purchase order. The State assumes no responsibility for goods until accepted by the State at the receiving point in good condition. Title and risk of loss or damage to all items shall be the responsibility of the supplier until accepted by the receiving agency. The supplier(s) awarded the Contract shall be responsible for filing, processing, and collecting any and all damage claims accruing prior to acceptance.
- 16.2. Supplier(s) awarded the Contract shall be required to deliver products and services as bid on or before the required date. Deviations, substitutions or changes in products and services shall not be made unless expressly authorized in writing by the Central Purchasing Division.

17. INVOICING AND PAYMENT

- 17.1. Pursuant to 74 O.S. §85.44(B), invoices will be paid in arrears after products have been delivered or services provided.
- 17.2. Interest on late payments made by the State of Oklahoma is governed by 62 O.S. §34.71 and 62 O.S. §34.72.

18. TAX EXEMPTION

State agency acquisitions are exempt from sales taxes and federal excise taxes. Bidders shall not include these taxes in price quotes.

19. AUDIT AND RECORDS CLAUSE

- 19.1. As used in this clause, "records" includes books, documents, accounting procedures and practices, and other data, regardless of type and regardless of whether such items are in written form, in the form of computer data, or in any other form. In accepting any Contract with the State, the successful bidder(s) agree any pertinent State or Federal agency will have the right to examine and audit all records relevant to execution and performance of the resultant Contract.
- 19.2. The successful bidder(s) awarded the Contract(s) is required to retain records relative to the Contract for the duration of the Contract and for a period of seven (7) years following completion and/or termination of the Contract. If an audit, litigation, or other action involving such records is started before the end of the seven (7) year period, the records are required to be maintained for two (2) years from the date that all issues arising out of the action are resolved, or until the end of the two (2) year retention period, whichever is later.

20. NON-APPROPRIATION CLAUSE

The terms of any Contract resulting from the solicitation and any Purchase Order issued for multiple years under the Contract are contingent upon sufficient appropriations being made by the Legislature or other appropriate government entity. Notwithstanding any language to the contrary in the solicitation, purchase order, or any other Contract document, the procuring agency may terminate its obligations under the Contract if sufficient appropriations are not made by the Legislature or other appropriate governing entity to pay amounts due for multiple year agreements. The Requesting (procuring) Agency's decisions as to whether sufficient appropriations are available shall be accepted by the supplier and shall be final and binding.

21. CHOICE OF LAW

Any claims, disputes, or litigation relating to the solicitation, or the execution, interpretation, performance, or enforcement of the Contract shall be governed by the laws of the State of Oklahoma.

22. CHOICE OF VENUE

Venue for any action, claim, dispute or litigation relating in any way to the Contract shall be in Oklahoma County, Oklahoma.

23. TERMINATION FOR CAUSE

- 23.1.** The supplier may terminate the Contract for default or other just cause with a 30-day written request and upon written approval from the Central Purchasing Division. The State may terminate the Contract for default or any other just cause upon a 30-day written notification to the supplier.
- 23.2.** The State may terminate the Contract immediately, without a 30-day written notice to the supplier, when violations are found to be an impediment to the function of an agency and detrimental to its cause, when conditions preclude the 30-day notice, or when the State Purchasing Director determines that an administrative error occurred prior to Contract performance.
- 23.3.** If the Contract is terminated, the State shall be liable only for payment for products and/or services delivered and accepted.

24. TERMINATION FOR CONVENIENCE

- 24.1.** The State may terminate the Contract, in whole or in part, for convenience if the State Purchasing Director determines that termination is in the State's best interest. The State Purchasing Director shall terminate the Contract by delivering to the supplier a Notice of Termination for Convenience specifying the terms and effective date of Contract termination. The Contract termination date shall be a minimum of 60 days from the date the Notice of Termination for Convenience is issued by the State Purchasing Director.
- 24.2.** If the Contract is terminated, the State shall be liable only for products and/or services delivered and accepted, and for costs and expenses (exclusive of profit) reasonably incurred prior to the date upon which the Notice of Termination for Convenience was received by the supplier.

25. INSURANCE

The successful bidder(s) awarded the Contract shall obtain and retain insurance, including workers' compensation, automobile insurance, medical malpractice, and general liability, as applicable, or as required by State or Federal law, prior to commencement of any work in connection with the Contract. The supplier awarded the Contract shall timely renew the policies to be carried pursuant to this section throughout the term of the Contract and shall provide the Central Purchasing Division and the procuring agency with evidence of such insurance and renewals.

26. EMPLOYMENT RELATIONSHIP

The Contract does not create an employment relationship. Individuals performing services required by this Contract are not employees of the State of Oklahoma or the procuring agency. The supplier's employees shall not be considered employees of the State of Oklahoma nor of the procuring agency for any purpose, and accordingly shall not be eligible for rights or benefits accruing to state employees.

27. COMPLIANCE WITH THE OKLAHOMA TAXPAYER AND CITIZEN PROTECTION ACT OF 2007

By submitting a bid for services, the bidder certifies that they, and any proposed subcontractors, are in compliance with 25 O.S. §1313 and participate in the Status Verification System. The Status Verification System is defined in 25 O.S. §1312 and includes but is not limited to the free Employment Verification Program (E-Verify) available at www.dhs.gov/E-Verify.

28. COMPLIANCE WITH APPLICABLE LAWS

The products and services supplied under the Contract shall comply with all applicable federal, state and local laws, and the supplier shall maintain all applicable licenses and permit requirements.

29. SPECIAL PROVISIONS

Special Provisions apply with the same force and effect as these General Provisions. However, conflicts or inconsistencies shall be resolved in favor of the Special Provisions.

B. SPECIAL PROVISIONS

B.1. Contract Period

B.1.1. This contract is for a twelve (12) month period, commencing on the Date of Award through one year, with option to renew for up to three (3) additional one year periods.

B.2. Agreement Period

B.2.1. The agreement period for this contract will be date of award through four (4) years.

B.3. Required Delivery

B.3.1. Delivery should be made within 120 calendar days after receipt of order by the successful vendor. If circumstances beyond the control of the vendor causes delivery to be longer than 120 calendar days, the vendor shall notify the ordering agency immediately. Vehicles with a build date longer than 120 days, should be noted on their price sheet.

B.3.2. The base price for a vehicle is to include delivery within 150 miles from the awarded dealer's location to the delivery address for the ordering end user. Vehicles delivered by a dealer are to be delivered to the end user with a ½ tank of gas. If end user elects to pick up their vehicle at the dealers location, that vehicle is to be turned over to the end user with a full tank of gas.

B.3.3. A price for agencies to have vehicles delivered to locations outside of the 150 mile radius is contained on each price sheet and are to be turned over to the end user with a ½ tank of gas.

B.3.4. Vehicles ordered as a result of this contract should be delivered to the ordering location with no more than an additional 175 miles over the distance from the manufacturer to the delivery location on the odometer. Any vehicle that will have more than the additional 175 miles on the odometer at time of delivery requires pre-notification/explanation to the ordering entity.

B.4. Type of Contract

B.4.1. This is a firm fixed price contract for indefinite delivery and indefinite quantity for the supplies/services specified.

B.5. Authorized Users

B.5.1. RFP's shall cover requirements during the specified period for all State Departments, Boards, Commissions, Agencies and Institutions. The Oklahoma Statutes state that Counties, School Districts and Municipalities may avail themselves of the contract subject to the approval of the successful offeror(s).

CHECK APPROPRIATE BLOCK

B.5.1.1. _____ Yes, permits usage by other than State Agencies

B.5.1.2. _____ No, permits usage by State Agencies only.

B.6. Notice of Award

B.6.1. Notice of award letter resulting from this RFP will be furnished to each successful vendor and shall result in a binding contract without further action by either party. It shall be the successful vendor's responsibility to reproduce and distribute copies to all authorized dealers listed in your RFP response. No additions, deletions or changes of any kind shall be made to this contract without prior approval of Central Purchasing.

B.7. Extension of Contract

B.7.1. The State may extend the term of this contract up to 90 days if mutually agreed upon by both parties in writing.

B.8. Contractor Invoices

B.8.1. The vendor shall be paid upon submission of proper certified invoices to the ordering agency at the prices stipulated on the contract. Invoices shall contain the contract number and purchase order number. Failure to follow these instructions may result in delay of processing invoices for payment. The Company or Corporation submitting a proposal shall be the only office authorized to receive orders, invoice and receive payment. If the Vendor wishes to ship or provide service from a point other than

the address listed on the face of the RFP, the Vendor will furnish a list of these locations. No ordering or invoicing will be done at these locations.

B.8.2. Invoicing shall be made in accordance with instructions by agency or division issuing the purchase order.

B.8.3. If you are paid more than 45 days after submitting a proper invoice, you may be entitled to claim an interest penalty. Contact the Office of State Finance for a copy of the regulations.

B.8.4. In cases of partial delivery the state agency may make partial payment, dependent on the dollar value, or hold all invoices for final delivery to be completed.

B.9. Prompt Payment Discounts

B.9.1. Discounts for prompt payment will not be considered in the evaluation of offers. However, any discount offered will be annotated on the award and may be taken if payment is made within the discount period.

B.10. Gratuities

B.10.1. The right of the successful vendor to perform under this contract may be terminated by written notice if the Contracting Officer determines that the successful vendor, or its agent or another representative offered or gave a gratuity (e.g., an entertainment or gift) to an officer, official or employee of Central Purchasing.

B.11. RFP Proposal Conformity

B.11.1. By submitting a response to this solicitation, the vendor attests that the supplies or services conform to specified contract requirements.

B.12. Warranty

B.12.1. The Successful vendor agrees the products furnished under this contract shall be covered by the most favorable commercial warranties the contractor gives to any customer for such products; and rights and remedies provided herein are in addition to and do not limit any rights afforded to the State of Oklahoma by any other clause of this contract.

B.13. Contract Usage Reporting Requirements

B.13.1. Usage reports for this contract are to be submitted quarterly shall include but not limited to the following:

B.13.1.1. Order Information: contract number (if any), date, order or purchase order number.

B.13.1.2. Customer Information: agency name, location

B.13.1.3. Product or Service Information: category, detailed product or service description, manufacturer, manufacturer item number, vendor SKU, unit of measure, list price (current UOM).

B.13.1.4. Cost Specification: price paid (per contract), quantity purchased, extended price, shipping or other charges (if applicable), total invoice price per line.

B.13.2. Vendor shall submit reports quarterly. Reports shall be submitted quarterly regardless of quantity. Quarterly reports are to be received within 30 days following the reporting period described in Section B.12.3.

B.13.3. Usage reports shall be sent electronically to strategic.sourcing@omes.ok.gov and are to be submitted in Microsoft Excel format. Contract quarterly reporting periods shall be:

B.13.3.1. 1st Quarter: January 1 through March 31

B.13.3.2. 2nd Quarter: April 1 through June 30

B.13.3.3. 3rd Quarter: July 1 through September 30

B.13.3.4. 4th Quarter: October 1 through December 31

B.13.4. Failure to provide usage reports shall result in cancellation or suspension of contract.

B.13.5. A Quarterly Usage report template is posted as an Excel Spreadsheet with this solicitation.

B.14. Energy Conservation

B.14.1. Oklahoma is an energy conservation State and we welcome any comments on your RFP that would indicate energy savings.

B.15. Conflict of Interest

B.15.1. The Request for Proposal hereunder is subject to the provisions of the Oklahoma Statutes. All Vendors must disclose with the RFP the name of any officer, director or agent who is also an employee of the State of Oklahoma or any of its agencies. Further, all Vendors must disclose the name of any State Employee who owns, directly or indirectly, an interest of five percent (5%) or more in the suppliers firm or any of its branches.

B.16. Patents and Royalties

B.16.1. The Vendor, without exception, shall indemnify and save harmless the State of Oklahoma and its employees from liability of any nature or kind, including cost and expenses for or on account of any copyrighted, patented, or unpatented invention, process, or article manufactured or used in the performance of the contract including its use by the State of Oklahoma. If the vendor uses any design, device or materials covered by letters, patent or copyright, it is mutually agreed and understood without exception that the RFP prices shall include all royalties or cost arising from the use of such design, device, or materials in any way involved in the work.

B.17. Product Acceptability

B.17.1. Bids will only be considered on products, manufactured or produced for distribution and use in the United States and Canada.

B.17.2. Products shall be new and current. Factory reconditioned, refurbished or second equipment will not be accepted.

B.18. Product Availability

B.18.1. Vehicles must be a current product model and available for general marketing purposes at the opening of this solicitation. Bidders must use best effort to assure product availability through the duration of the contract period.

B.18.2. The awarded dealer will provide vehicles for length of the contract period without any price increases. The only exception will be if a model is discontinued or is replaced by a new model. Awarded vendors shall notify Central Purchasing of the new model and provide pricing sheets with vehicle information within 30 days of discontinuation. The new model will only be added if approved by Central Purchasing.

B.19. Authorized Representative & Documentation

B.19.1. Bidders may offer any brand for which they are an authorized representative, which meets or exceeds the specification. **Only Oklahoma licensed dealers may submit proposals for this contract.** Per Oklahoma State Statute, Title 74, Section 564, any person or firm engaged in the sale or distribution of motor vehicles within the State of Oklahoma must possess a current, valid Motor Vehicle Dealer License. Bidders should submit a copy of both their Oklahoma dealer's license and a copy of the Manufacturer's license for each manufacturer they are bidding.

B.19.2. At the request of any State Agency, County, City, Municipality, School District, bidders must provide written documentation that guarantees that purchased buses meet all Federal, State, and State Board of Education standards for the year it was manufactured.

B.20. Price Adjustments

B.20.1. Manufacturer's price increases, or other increases in the cost of doing business may not be passed on to the State of Oklahoma. Any price decrease effectuated during the contract period by reason of market change shall be passed onto the State of Oklahoma. No price reduction on a statewide contract may be offered to an agency unless that reduction is offered to all agencies. The only exception to price increases is listed in B.19.2.

B.20.2. If the base price of a vehicle increases due to change in equipment or emissions, the dealer can increase the base price of the vehicle by the amount of the price increase. A letter from the manufacturer documenting the change and the amount of the change must be provided to Central Purchasing for review/approval before the contract base price will be changed.

B.21. Mandatory Contract

B.21.1. This contract is mandatory for State of Oklahoma agencies.

B.22. Extension of Retail Price with Rebates over Contract Price

B.22.1. If the Retail Price is lower than the contract price due to promotions or discounts, the Vendor shall charge the State the Retail price.

B.22.2. Any other instance that causes the Retail price to be lower than the contract price, the Vendor shall charge the State the Retail price.

B.23. Negotiations

B.23.1. The State may elect to negotiate with selected vendors during the procurement process to get the best price and business terms for its citizens. Negotiations would be through the State Purchasing Director or his designee. The State will consider all cost and business terms to be negotiable and not artificially constrained by internal corporate policies. In short, firms that contend that they lack flexibility because of their corporate policy on a particular negotiation item will face a significant disadvantage and may not be considered.

B.24. State and Federal Taxes

B.24.1. Purchases by the State of Oklahoma are not subject to any sales tax or Federal Excise tax. Exemption certificates will be furnished upon request.

B.25. Contract Management Fee

B.25.1. As provided by Oklahoma State Statute §85.33A, the Department of Central Services assesses an Administrative Fee in the sum of one half of one (½ of 1%) percent on all sales transacted by any entity under this contract.

B.25.2. Supplier agrees to annotate the resultant amount on the quarterly "Contract Usage Report" as listed in B13. and make payment by company check to OMES – Central Purchasing Division within thirty (30) calendar days from the completion of the quarterly reporting period as listed in B13.3. To ensure the payment is credited properly, the supplier must indentify the check as a "Contract Management Fee" and include the following information with the payment: SW110 School Bus Contract, the report amount and the reporting period covered. The Contract Management Fee shall be mailed to:

OMES

Agency Business Services

3812 N. Santa Fe, Suite 290

Oklahoma City, OK 73118-8500

B.25.3. Failure to remit the fee quarterly may result in the cancellation of the contract. The State Contract Management Fee is non-refundable when an item is rejected, returned or declined due to the Supplier's failure to perform or comply with specifications or requirements of the contract.

C. SOLICITATION SPECIFICATIONS

The effective date of this document was September, 29 2012. After that time, all new school buses sold in Oklahoma will have to comply with the minimum specifications provided here. This document does not require a retrofit of existing buses, but used buses manufactured after the effective date will have to meet this standard.

Specifications for Type A, B, C, and D Buses

The following requirements are Mandatory.

C.1. AIR CLEANER

C.1.1. A dry element air cleaner shall be provided.

C.1.2. All diesel engine air filters shall include a latch-type restriction indicator that retains the maximum restriction developed during operation of the engine. The indicator should include a reset control so the indicator can be returned to zero when desired.

C.2. AISLE

C.2.1. All emergency exit doors shall be accessible by a 12-inch minimum aisle. The aisle shall be unobstructed at all times by any type of barrier, seat, wheelchair or tie-down, unless a flip seat is installed and occupied. The track of a track seating system is exempt from this requirement. A flip

seat in the unoccupied (up) position shall not obstruct the 12-inch minimum aisle to any side emergency exit door.

C.3. AXLES

- C.3.1. The front and rear axle and suspension systems shall have a gross axle weight rating (GAWR) at ground commensurate with the respective front and rear weight loads of the bus loaded to the rated passenger capacity.

C.4. BACK-UP WARNING ALARM

- C.4.1. An automatic audible alarm shall be installed behind the rear axle and shall comply with the published Backup Alarm Standards (SAE J994b), providing a minimum of 112 dBA, or shall have a variable volume feature that allows the alarm to vary from 87 dBA to 112 dBA sound level, staying at least 5 dBA above the ambient noise level.

C.5. BRAKES: GENERAL

- C.5.1. The chassis brake system shall conform to the provisions of FMVSS Nos. 105, Hydraulic and Electric Brake Systems, 106, Brake Hoses, and 121, Air Brake Systems, as applicable.
- C.5.2. The anti-lock brake system (ABS), provided in accordance with FMVSS No. 105, Hydraulic and Electric Brake Systems or No. 121, Air Brake Systems, shall provide wheel speed sensors for each front wheel and for each wheel on at least one rear axle. The system shall provide anti-lock braking performance for each wheel equipped with sensors (Four Channel System).
- C.5.3. All brake systems shall be designed to permit visual inspection of brake lining wear without removal of any chassis component(s). D. The brake lines, booster-assist lines, and control cables shall be protected from excessive heat, vibration and corrosion and installed in a manner that prevents chafing.
- C.5.4. The parking brake system for either air or hydraulic service brake systems may be of a power-assisted design. The power parking brake actuator should be a device located on the instrument panel within reach of seated a 5th percentile female driver. As an option, the parking brake may be set by placing the automatic transmission shift control mechanism in the "park" position.
- C.5.5. The power-operated parking brake system may be interlocked to the engine key switch. Once the parking brake has been set and the ignition switch turned to the "off" position, the parking brake cannot be released until the key switch is turned back to the "on" position.

C.6. BRAKES: HYDRAULIC

- C.6.1. Buses using a hydraulic-assist brake shall be equipped with audible and visible warning signals that provide a continuous warning to the driver indicating a loss of fluid flow from the primary source or a failure of the back-up pump system.

C.7. BRAKES: AIR

- C.7.1. The air pressure supply system shall include a desiccant-type air dryer installed according to the manufacturer's recommendations. The air pressure storage tank system shall incorporate an automatic drain valve.
- C.7.2. The chassis manufacturer shall provide an accessory outlet for air-operated systems installed by the body manufacturer. This outlet shall include a pressure protection valve to prevent loss of air pressure in the service brake reservoir.
- C.7.3. For air brake systems, an air pressure gauge shall be provided in the instrument panel capable of complying with Commercial Driver's License (CDL) pre-trip inspection requirements.
- C.7.4. Air brake-equipped buses may be equipped with a service brake interlock. If equipped with a service brake interlock, the parking brake cannot be released until the brake pedal is depressed.
- C.7.5. Air brake systems shall include a system for anti-compounding of the service brakes and parking brakes.
- C.7.6. Air brakes shall have both a visible and audible warning device whenever the air pressure falls below the level where warnings are required under FMVSS No. 121, Air Brake Systems.

C.8. BUMPER: FRONT

- C.8.1. School buses shall be equipped with a front bumper.

- C.8.2.** The front bumper on buses of Type A-2 (with GVWR greater than 14,500 pounds), Type B, Type C, and Type D shall be equivalent in strength and durability to pressed steel channel at least 3/16 inches thick and not less than 8 inches wide (high). It shall extend beyond the forward-most part of the body, grille, hood and fenders and shall extend to the outer edges of the fenders at the bumper's top line. Type A buses having a GVWR of 14,500 pounds or less may be equipped with an OEM-supplied front bumper. The front bumper shall be of sufficient strength to permit being pushed by another vehicle on a smooth surface with a 5 degree, (8.7 percent) grade, without permanent distortion. The contact point on the front bumper is intended to be between the frame rails with as wide a contact area as possible. If the front bumper is used for lifting, the contact points shall be under the bumper attachments to the frame rail brackets unless the manufacturer specifies different lifting points in the owner's manual. Contact and lifting pressures should be applied simultaneously at both lifting points.
- C.8.3.** The front bumper, except breakaway bumper ends, shall be of sufficient strength to permit pushing a vehicle of equal gross vehicle weight, per Section B, without permanent distortion to the bumper, chassis or body.
- C.8.4.** The bumper shall be designed or reinforced so that it will not deform when the bus is lifted by a chain that is passed under the bumper (or through the bumper if holes are provided for this purpose) and attached to both tow hooks/eyes. For the purpose of meeting this specification, the bus shall be empty and positioned on a level, hard surface and both tow hooks/eyes shall share the load equally.

C.9. BUMPER: REAR

- C.9.1.** The bumper on Type A-1 buses shall be a minimum of 8 inches wide (high). Bumpers on Types A-2, B, C and D buses shall be a minimum of 9½ inches wide (high). The bumper shall be of sufficient strength to permit being pushed by another vehicle of similar size and being lifted by the bumper without permanent distortion. The bumper shall wrap around the back corners of the bus. It shall extend forward at least 12 inches, measured from the rear-most point of the body at the floor line, and shall be mounted flush with the sides of the body or protected with an end panel. The bumper shall be attached to the chassis frame in such a manner that it may be removed. It shall be braced to resist deformation of the bumper resulting from impact from the rear or the side. It shall be designed to discourage hitching of rides by an individual. The bumper shall extend at least one inch beyond the rear-most part of the body surface, measured at the floor line. The bottom of the rear bumper shall not be more than 30 inches above ground level.

C.10. CERTIFICATION

- C.10.1.** Upon request of the state agency having student transportation jurisdiction, the chassis and body manufacturer(s) shall certify that its(their) product(s) meets the state's minimum standards on items which are not covered by FMVSS certification requirements of 49 CFR, Part 567: Certification.

C.11. CHILD CHECK ALARM SYSTEM

- C.11.1.** Each school bus shall be equipped with a "Child-Check" system that is armed when the red lights are turned on at the first passenger stop. The system will require the driver to walk to the rearmost interior of the bus after each trip to deactivate the system via push button and to ensure that no passengers are left on the bus. The system shall sound the vehicle horn and flash the headlights if the driver fails to deactivate the system within 60 seconds of turning the ignition off. Type A1 buses may activate the red pupil warning lights in lieu of the headlights.
- C.11.2.** The system must not affect or interfere with any other existing operating or electrical component (e.g., turn signals, brake lights, stop signal arm, etc.)
- C.11.3.** The system must permit the driver complete control of the ignition switch and not interfere with engine operation or shutdown.
- C.11.4.** The system may emit a reminder tone or signal during delay period.
- C.11.5.** The system shall not have a bypass.
- C.11.6.** The system shall be deactivated by the use of a heavy-duty push button placed on the left (position as determined from the normal driving position as seated in the driver's seat looking in the direction of forward travel roadside "driver side") rear bulkhead or above the left (roadside "driver side") rear passenger window for Type A, B, C, and D FE buses. The push button shall be

placed above the left rear passenger window for Type D RE buses. This button shall be clearly marked.

C.12. CLUTCH

- C.12.1.** Clutch torque capacity shall be equal to or greater than the engine torque output. A starter interlock shall be installed to prevent actuation of the starter if the clutch pedal is not depressed.

C.13. COLOR

- C.13.1.** The school bus body shall be painted National School Bus Yellow (NSBY). (See APPENDIX A in *National School Transportation Specifications and Procedures 2010*)
- C.13.2.** The body exterior trim, rub rails and background of red and amber flashers, shall be black or NSBY. Rub rails may be painted in such a way that only the entire raised center section of the rail is black.
- C.13.3.** Except for the vertical portion of the front and rear roof caps, the roof of the bus shall be painted white. (See illustration in Attachment "C", Placement of Retroreflective Markings.)
- C.13.4.** The chassis and front bumper shall be black. Body, cowl, hood and fenders shall be in National School Bus Yellow (NSBY). The flat top surface of the hood may be non-reflective black or NSBY. Wheels may be silver, gray, white, yellow or black.
- C.13.5.** Multi-Function School Activity Buses (MFSABs) shall be exempt from these requirements.

C.14. CONSTRUCTION

- C.14.1.** Side Intrusion Test: The bus body shall be constructed to withstand an intrusion force equal to the curb weight of the vehicle or 20,000 pounds, whichever is less.
- C.14.2.** Each vehicle shall be capable of meeting this requirement when tested in accordance with the procedures set forth below. The complete body structure, or a representative seven-body section mock up with seats installed, shall be loadtested at a location 24±2 inches above the floor line, with a maximum 10 inch diameter cylinder, 48 inches long, mounted in a horizontal plane. The cylinder shall be placed as close as practical to the mid-point of the tested structure, spanning two internal vertical structural members. The cylinder shall be statically loaded to the required force of curb weight or 20,000 pounds, whichever is less, in a horizontal plane with the load applied from the exterior toward the interior of the test structure. When the minimum load has been applied, the penetration of the loading cylinder into the passenger compartment shall not exceed 10 inches from its original point of contact. There can be no separation of lapped panels or construction joints. Punctures, tears or breaks in the external panels are acceptable but are not permitted on any adjacent interior panel. Body companies shall certify compliance with this intrusion requirement, and include test results, as requested. Construction shall be reasonably dust-proof and watertight.

C.15. CROSSING CONTROL ARM

- C.15.1.** School buses may be equipped with a crossing control arm mounted on the right side of the front bumper. When opened, this arm shall extend in a line parallel to the body side and aligned with the right front wheel.
- C.15.2.** All components of the crossing control arm and all connections shall be weatherproofed. The crossing control arm shall incorporate system connectors (electrical, vacuum or air) at the gate and shall be easily removable to allow for towing of the bus. The crossing control arm shall be constructed of non-corrodible or nonferrous material or shall be treated in accordance with the body sheet metal specification. (See BUS BODY AND CHASSIS SPECIFICATIONS, Metal Treatment.) There shall be no sharp edges or projections that could cause injury or be a hazard to students. The end of the arm shall be rounded. The crossing control arm shall extend a minimum of 70 inches (measured from the bumper at the arm assembly attachment point) when in the extended position. The crossing control arm shall not extend past the end of the bumper when in the stowed position. The crossing control arm shall extend simultaneously with the stop signal arm(s), activated by stop signal arm controls. An automatic recycling interrupt switch shall be installed for temporarily disabling the crossing control arm. The assembly shall include a device attached to the bumper near the end of the arm to automatically retain the arm while in the stowed position. That device shall not interfere with normal operations of the crossing control arm.

C.16. DEFROSTERS

- C.16.1.** Defrosting and defogging equipment shall direct a sufficient flow of heated air onto the windshield, the window to the left of the driver, and the glass in the viewing area directly to the right of the driver to eliminate frost, fog and snow. (Exception: The requirements of this standard do not apply to the exterior surfaces of double pane storm windows.)
- C.16.2.** The defrosting system shall conform to SAE J381, *Windshield Defrosting Systems Test Procedure and Performance Requirements—Trucks, Buses, and Multipurpose Vehicles*.
- C.16.3.** The defroster and defogging system shall be capable of furnishing heated, outside ambient air, except that the part of the system furnishing additional air to the windshield, entrance door and stepwell may be the re-circulating air type.
- C.16.4.** Auxiliary fans are not considered defrosting or defogging systems.
- C.16.5.** Portable heaters shall not be used.

C.17. DOORS

- C.17.1.** The entrance door shall be under the driver's control, designed to afford easy release and to provide a positive latching device on manual operating doors to prevent accidental opening. When a hand lever is used, no part shall come together that will shear or crush fingers. Manual door controls shall not require more than 25 pounds of force to operate at any point throughout the range of operation, as tested on a 10% grade, both uphill and downhill.
- C.17.2.** The entrance door shall be located on the right side of the bus, opposite and within direct view of the driver.
- C.17.3.** The entrance door shall have a minimum horizontal opening of 24 inches and a minimum vertical opening of 68 inches.
- C.17.4.** The entrance door shall be a split-type door and shall open outward.
- C.17.5.** All entrance door glass shall be approved safety glass. The bottom of each lower glass panel shall be not more than 10 inches from the top surface of the bottom step. The top of each upper glass panel when viewed from the interior shall be not more than three inches below the interior door control cover or header pad.
- C.17.6.** Vertical closing edges on entrance doors shall be equipped with flexible material.
- C.17.7.** All door openings shall be equipped with padding at the top edge of the opening. Padding shall be at least three inches wide and one inch thick and extend the full width of the door opening.
- C.17.8.** On power-operated entrance doors, the emergency release valve, switch or device to release the entrance door must be placed above or to the immediate left or immediate right of the entrance door and must be clearly labeled. The emergency release valve, switch or device shall work in the absence of power.

C.18. DRIVE SHAFT

- C.18.1.** The drive shaft shall be protected by a metal guard or guards around the circumference of the drive shaft to reduce the possibility of its whipping through the floor or dropping to the ground if broken.

C.19. ELECTRICAL SYSTEM

C.19.1. Battery

- C.19.1.1.** The storage batteries shall have minimum cold cranking capacity rating (cold cranking amps) equal to the cranking current required for 30 seconds at 0 degrees Fahrenheit and a minimum reserve capacity rating of 120 minutes at 25 amps. Higher capacities may be required depending upon optional equipment and local environmental conditions.
- C.19.1.2.** The manufacturer shall securely attach the battery on a slide-out or swingout tray in a closed, vented compartment in the body skirt so that the battery is accessible for convenient servicing from the outside. When in the stored position, the tray shall be retained by a securing mechanism capable of holding the tray [with battery(ies)] in position when subjected

to a 5g load from any direction. The battery compartment door or cover, if separate from the tray, shall be hinged at the front or top. It shall be secured by a positive operated latching system or other type fastener. The door may be an integral part of the battery slide tray. The door or cover must fit tightly to the body and not present sharp edges or snagging points. Battery cables shall meet SAE requirements. Battery cables shall be of sufficient length to allow the battery tray to fully extend. The battery compartment is required on Type A-1 diesel buses, and any battery(ies) mounted on the frame by the chassis manufacturer shall be relocated to the battery compartment.

- C.19.1.3.** All batteries are to be secured in a sliding tray except that on van conversion or cutaway front-section chassis batteries may be secured in accordance with the manufacturer's standard configuration. In these cases, the final location of the battery and the appropriate cable lengths shall be agreed upon mutually by the chassis and body manufacturers. However, in all cases the battery cable provided with the chassis shall have sufficient length to allow some slack and shall be of sufficient gauge to carry the required amperage.
- C.19.1.4.** Buses may be equipped with a battery shut-off switch. The switch is to be placed in a location not readily accessible to the driver or passengers.

C.19.2. Alternator

- C.19.2.1.** All Type A-2 and Type B buses with a GVWR of 15,000 pounds or less shall have a minimum 130-amp alternator.
- C.19.2.2.** All buses over 15,000 pounds GVWR shall be equipped with a heavy-duty truck- or bus-type alternator having a minimum output rating of 240 amps or higher and should produce a minimum current output of 50 percent of the rating at engine idle speed.
- C.19.2.3.** Buses equipped with an electrically powered wheelchair lift, air conditioning or other accessories may be equipped with a device that monitors the electrical system voltage and advances the engine idle speed when the voltage drops to, or below, a pre-set level.
- C.19.2.4.** A belt-driven alternator shall be capable of handling the rated capacity of the alternator with no detrimental effect on any other driven components. (For estimating required alternator capacity, see School Bus Manufacturers Technical Council's publication, "School Bus Technical Reference," available at <http://www.nasdpts.org>.)
- C.19.2.5.** A direct/gear-drive alternator is permissible in lieu of a belt-driven alternator.

C.19.3. Electrical Components

- C.19.3.1.** Materials in all electrical components shall contain no mercury.

C.19.4. Wiring, Chassis

- C.19.4.1.** All wiring shall conform to current applicable recommended practices of the Society of Automotive Engineers (SAE). All wiring shall use color and at least one other method for identification. The other method shall be either a number code or name code, and each chassis shall be delivered with a wiring diagram that illustrates the wiring of the chassis.
- C.19.4.2.** The chassis manufacturer of an incomplete vehicle shall install a readily accessible terminal strip or connector on the body side of the cowl or in an accessible location in the engine compartment of vehicles designed without a cowl. The strip or connector shall contain the following terminals for the body connections:
 - C.19.4.2.1. Main 100-amp body circuit,
 - C.19.4.2.2. Tail lamps,
 - C.19.4.2.3. Right turn signal,
 - C.19.4.2.4. Left turn signal,
 - C.19.4.2.5. Stop lamps,
 - C.19.4.2.6. Back-up lamps, and
 - C.19.4.2.7. Instrument panel lamps (controlled by dimmer switch).
- C.19.4.3.** An appropriate identifying diagram (color plus a name or number code) for all chassis electrical circuits shall be provided to the body manufacturer for distribution to the end user.

- C.19.4.4.** Wiring for the headlamp system must be separate from the electronic controlled body solenoid/module.
- C.19.5.** Wiring, Body
- C.19.5.1.** All wiring shall conform to current SAE standards.
- C.19.5.2.** All wiring shall have an amperage capacity exceeding the design load by at least 25%. All wiring splices are to be accessible and noted as splices on the wiring diagram.
- C.19.5.3.** A body wiring diagram, sized to be easily read, shall be furnished with each bus body or affixed to an area convenient to the electrical accessory control panel.
- C.19.5.4.** The body power wire shall be attached to a special terminal on the chassis.
- C.19.5.5.** Each wire passing through metal openings shall be protected by a grommet.
- C.19.5.6.** Wires not enclosed within the body shall be fastened securely at intervals of not more than 18 inches. All joints shall be soldered or joined by equally effective connectors, which shall be water-resistant and corrosion resistant.
- C.19.5.7.** Wiring shall be arranged in circuits, as required, with each circuit protected by a fuse breaker or electronic protection device. A system of color and number-coding shall be used, and an appropriate identifying diagram shall be provided to the end user, along with the wiring diagram provided by the chassis manufacturer. The wiring diagrams shall be specific to the bus model supplied and shall include any changes to wiring made by the body manufacturer. Chassis wiring diagrams shall be supplied to the end user. The following body interconnecting circuits shall be color-coded, as noted:

FUNCTION COLOR

- Left Rear Directional Lamp Yellow
- Right Rear Directional Lamp Dark Green
- Stop Lamps Red
- Back-up Lamps Blue
- Tail Lamps Brown
- Ground White
- Ignition Feed, Primary Feed Black

The color of the cables shall correspond to SAE J1128, *Low-Tension Primary Cable*.

- C.19.5.8.** Wiring shall be arranged in at least six regular circuits, as follows:
- C.19.5.8.1. Head, tail, stop (brake), clearance and instrument panel lamps;
- C.19.5.8.2. Step well lamps shall be actuated when the entrance door is open;
- C.19.5.8.3. Dome lamps;
- C.19.5.8.4. Ignition and emergency door signal;
- C.19.5.8.5. Turn signal lamps; and
- C.19.5.8.6. Alternately flashing signal lamps.
- C.19.5.9.** Any of the above combination circuits may be subdivided into additional independent circuits.
- C.19.5.10.** Heaters and defrosters shall be wired on an independent circuit.
- C.19.5.11.** Whenever possible, all other electrical functions (such as sanders and electric-type windshield wipers) shall be provided with independent and properly protected circuits.
- C.19.5.12.** Each body circuit shall be coded by number or letter on a diagram of circuits and shall be attached to the body in a readily accessible location.
- C.19.6.** Buses shall be equipped with a 12-volt power port in the driver's area.
- C.19.7.** A manual noise suppression switch shall be installed in the control panel. The switch shall be labeled and alternately colored. This switch shall be an on/off type that deactivates body

equipment that produces noise, including at least the AM/FM radio, heaters, air conditioners, fans and defrosters. This switch shall not deactivate safety systems, such as windshield wipers or lighting systems.

C.19.8. The entire electrical system of the body shall be designed for the same voltage as the chassis on which the body is mounted.

C.19.9. EMERGENCY EQUIPMENT

C.19.9.1. Fire extinguisher

C.19.9.1.1. The bus shall be equipped with at least one 5 lb. UL-approved pressurized, dry chemical fire extinguisher. The extinguisher shall be secured in a mounted bracket, located in the driver's compartment and readily accessible to the driver and passengers. A pressure gauge shall be mounted on the extinguisher and shall be easily read without moving the extinguisher from its mounted position.

C.19.9.1.2. The fire extinguisher shall have a rating of 2-A:10-BC or greater. The operating mechanism shall be secured with a type of seal that will not interfere with the use of the fire extinguisher.

C.19.9.2. First aid kit

C.19.9.2.1.1. The bus shall have a removable, moisture-proof and dust-proof first aid kit in an accessible place in the driver's compartment. It shall be mounted and identified as a first aid kit. The location for the first aid kit shall be marked. Contents of the first aid kit shall be in compliance with state standards.

C.19.9.2.2. Suggested contents include:

- 2 – 1-inch x 2½ yards of adhesive tape rolls
- 24 – Sterile gauze pads 3x3 inches
- 100 – ¾ x 3 inches adhesive bandages
- 8 – 2-inch bandage compress
- 10 – 3-inch bandage compress
- 2 – 2-inch x 6 feet sterile gauze roller bandages
- 2 – Non-sterile triangular bandages, minimum 39x35x54 inches with two safety pins
- 3 – Sterile gauze pads 36x36 inches
- 3 – Sterile eye pads
- 1 – Rounded-end scissors
- 1 – Pair medical examination gloves
- 1 – Mouth-to-mouth airway

C.19.9.3. Body fluid clean-up kit

C.19.9.3.1. Each bus shall have a removable and moisture-proof body fluid clean-up kit accessible to the driver. It shall be mounted and identified as a body fluid clean-up kit. Minimum contents of the body fluid clean up kit shall be:

- 1 - Bio hazard bag with tie, 7-10 gal
- 1 - pr. gloves – Nitrile
- 1 - bag with scoop and small scraper
- 2 oz - absorbent powder
- 1 - mask – dust
- Paper towel
- Antiseptic Towelettes
- Cleanser

1 - black/brown plastic bag

Instructions

C.19.9.4. Warning devices

C.19.9.4.1. Each school bus shall contain at least three retroreflective triangle road warning devices that meet the requirements of FMVSS No. 125, Warning Devices. They shall be mounted in an accessible place.

C.19.9.5. Any piece of emergency equipment may be mounted in an enclosed compartment, provided the compartment is labeled in not less than one inch letters, identifying each piece of equipment contained therein.

C.20. EMERGENCY EXITS

C.20.1. Any installed emergency exit shall comply with the design and performance required by FMVSS No. 217, Bus Emergency Exits and Window Retention and Release, applicable to that type of exit, regardless of whether or not that exit is required by FMVSS No. 217.

C.20.2. Emergency window requirements

C.20.2.1. The rear emergency window shall have a lifting assistance device that will aid in lifting and holding the rear emergency window open.

C.20.2.2. Side emergency exit windows, when installed, may be vertically hinged on the forward side of the window. No side emergency exit window will be located above a stop arm.

C.20.3. Emergency door requirements

C.20.3.1. The upper portion of the emergency door shall be equipped with approved safety glazing, the exposed area of which shall be at least 400 square inches. The lower portion of the rear emergency door on Types A-2, B, C and D vehicles shall be equipped with a minimum of 350 square inches of approved safety glazing.

C.20.3.2. There shall be no steps leading to an emergency door except on Types C and D all-wheel drive buses.

C.20.3.3. Padding shall be affixed to the top edge of each emergency door opening. Padding shall be at least three inches wide and one inch thick and shall extend the full width of the door opening.

C.20.3.4. There shall be no obstruction higher than ¼ inch across the bottom of any emergency door opening. Fasteners used within the emergency exit opening shall be free of sharp edges or burrs.

C.20.4. Emergency exit requirements: The use of the following tables is to determine the required number and types of emergency exits to comply with this specification, based on the bus manufacturer's equipped seating capacity.

C.20.4.1. Use Table 1 if the bus contains a rear emergency door, or

C.20.4.2. Use Table 2 if the bus contains a rear pushout emergency window AND a left side emergency door, as required by FMVSS No. 217 for school buses without a rear emergency door.

C.20.4.3. When using either Table 1 or Table 2:

C.20.4.3.1. Enter the Table at the appropriate "CAPACITY" and select the desired row from the options for that capacity.

C.20.4.3.2. A school bus will meet the requirements of this specification and the requirements of FMVSS 217 if it contains the types and quantities of emergency exits listed on the row selected.

TABLE 1 BUSES WITH REAR EMERGENCY DOOR (All Front Engine Buses)						TABLE 2 BUSES WITH REAR PUSHOUT WINDOW AND LEFT SIDE EMERGENCY DOOR (All Rear Engine Buses)					
Available Combinations By Capacity	Manufacturers Equipped Capacity	Shall Have	And Shall Also Have			Available Combinations By Capacity	Manufacturers Equipped Capacity	Shall Have	And Shall Also Have		
		Roof Hatch	L. Side Emerg. Exit Windows	R. Side Emerg. Exit Windows	L. Side Emerg. Exit Door			Roof Hatch	L. Side Emerg. Exit Windows	R. Side Emerg. Exit Windows	R. Side Emerg. Exit Door
1-45	1-45	1	0	0	0	1-45	1-45	1	0	0	0
46-77	46-77	2	1	1	0	46-89	46-89	2	1	1	0
	46-77	2	0	0	1		46-89	2	0	0	1
78-93	78-93	2	2	2	0	90-105	90-105	2	2	2	0
	78-93	2	1	1	1		90-105	2	1	1	1

C.21. EXHAUST SYSTEM

- C.21.1. The exhaust pipe, after-treatment system and tailpipe shall be outside the bus body compartment and shall be attached to the chassis so any other chassis component is not damaged.
- C.21.2. The tailpipe and after-treatment system shall be constructed of a corrosion resistant tubing material at least equal in strength and durability to 16-gauge steel tubing of equal diameter.
- C.21.3. The tailpipe may be flush with, or shall not extend more than two inches beyond, the perimeter of the body for side-exit pipe or the bumper for rear-exit pipe. The exhaust system shall be designed such that exhaust gas will not be trapped under the body of the bus.
- C.21.4. The tailpipe shall exit to the left or right of the emergency exit door in the rear of the vehicle or to the left side of the bus in front of or behind the rear drive axle. The tailpipe exit location on all Types A-1 or B-1 buses may be in accordance to the manufacturer's standards. The tailpipe shall not exit beneath any fuel filler location, emergency door or lift door.
- C.21.5. The exhaust system shall be insulated in a manner to prevent any damage to any fuel system component.
- C.21.6. The design of the after treatment systems shall not allow active (non-manual) regeneration of the particulate filter during the loading and unloading of passengers. Manual regeneration systems will be designed such that unintentional operation will not occur.
- C.21.7. For after treatment systems that require Diesel Exhaust Fluid (DEF) to meet federally mandated emissions:
 - C.21.7.1. The composition of Diesel Exhaust Fluid (DEF) must comply with International Standard ISO 22241-1. Refer to engine manufacturer for any additional DEF requirements.
 - C.21.7.2. The DEF supply tank should be designed to meet a minimum ratio of 3 diesel fills to 1 DEF fill.

C.22. FENDERS: FRONT

- C.22.1. When measured at the fender line, the total spread of the outer edges of front fenders shall exceed the total spread of front tires when front wheels are in a straight-ahead position.
- C.22.2. Front fenders shall be properly braced and shall not require attachment to any part of the body.

C.23. FLOORS

- C.23.1. The floor in the under-seat area, including tops of wheel housings, driver's compartment and toeboard, shall be covered with an elastomer floor covering, having a minimum overall thickness of 1/8 inch and a calculated burn rate of 0.1 or less, using the test methods, procedures and formulas listed in FMVSS No. 302, Flammability of Interior Materials. The driver's area and toeboard area in all Type-A buses may be manufacturer's standard flooring and floor covering.

- C.23.2. The floor covering in the aisles shall be ribbed or other raised pattern elastomer and have a calculated burn rate of 0.1 or less using the test methods, procedures and formulas listed in FMVSS No. 302. Minimum overall thickness shall be 3/16 inch measured from tops of ribs.
- C.23.3. The floor covering must be permanently bonded to the floor and must not crack when subjected to sudden changes in temperature. Bonding or adhesive material shall be waterproof and shall be a type recommended by the manufacturer of floor-covering material. All seams shall be sealed with waterproof sealer.
- C.23.4. On Types B, C and D buses, a flush-mounted, screw-down plate that is secured and sealed shall be provided to access the fuel tank sending unit and/or fuel pump. This plate shall not be installed under flooring material.

C.24. FRAME

- C.24.1. Frame lengths shall be established in accordance with the design criteria for the complete vehicle.
- C.24.2. Making holes in top or bottom flanges or side units of the frame and welding to the frame shall not be permitted except as provided or accepted by the chassis manufacturer.
- C.24.3. Frames shall not be modified for the purpose of extending the wheel base.
- C.24.4. Any secondary manufacturer that modifies the original chassis frame shall provide a warranty at least equal to the warranty offered by the original equipment manufacturer (OEM) and shall certify that the modification and other parts or equipment affected by the modification are free from defects in material and workmanship under normal use and service intended by the OEM.

C.25. FUEL SYSTEM

- C.25.1. Fuel tank(s) having a minimum 30-gallon capacity shall be provided by the chassis manufacturer. Each tank shall be filled from and vented to the outside of the passenger compartment, and each fuel filler should be placed in a location where accidental fuel spillage will not drip or drain on any part of the exhaust system.
- C.25.2. The fuel system shall comply with FMVSS No. 301, Fuel System Integrity.
- C.25.3. Fuel tank(s) may be mounted between the chassis frame rails or outboard of the frame rails on either the left or right side of the vehicle.
- C.25.4. The actual draw capacity of each fuel tank shall be a minimum of 83 percent of the tank capacity.
- C.25.5. Installation of alternative fuel systems, including fuel tanks and piping from the tank to the engine, shall comply with all applicable fire codes in effect on the date of manufacture of the bus.
- C.25.6. Installation of Liquefied Petroleum Gas (LPG) tanks shall comply with National Fire Protection Association (NFPA) 58, Liquefied Petroleum Gas Code.
- C.25.7. Installation of Compressed Natural Gas (CNG) containers shall comply with FMVSS No. 304, Compressed Natural Gas Fuel Container Integrity.
- C.25.8. The CNG Fuel System shall comply with FMVSS No. 303, Fuel System Integrity of Compressed Natural Gas Vehicles.

C.26. GOVERNOR

- C.26.1. An electronic engine speed limiter shall be provided and set to limit engine speed, not to exceed the maximum revolutions per minute, as recommended by the engine manufacturer.

C.27. HANDRAILS

- C.27.1. At least one handrail shall be installed. The handrail(s) shall assist passengers during entry or exit and shall be designed to prevent entanglement, as evidenced by the passing of the NHTSA string and nut test.

C.28. HEATING SYSTEM, PROVISION FOR

- C.28.1. The chassis engine shall have plugged openings for the purpose of supplying hot water for the bus heating system. The engine shall be capable of supplying coolant at a temperature of at least 170 degrees Fahrenheit at the engine coolant thermostat opening. The coolant flow rate shall be 50 pounds per minute at the return end of 30 feet of one inch inside diameter automotive hot

water heater hose. (See SBMTC-001, Standard Code for Testing and Rating Automotive Bus Hot Water Heating and Ventilating Equipment.)

C.29. HEATING AND AIR CONDITIONING SYSTEMS

C.29.1. Heating System

- C.29.1.1.** The heater shall be hot water and/or combustion type.
- C.29.1.2.** If only one heater is used, it shall be fresh-air or combination fresh-air and recirculation type.
- C.29.1.3.** If more than one heater is used, additional heaters may be re-circulating air type.
- C.29.1.4.** The heating system shall be capable of maintaining bus interior temperatures, as specified in test procedure SAE J2233.
- C.29.1.5.** Auxiliary fuel-fired heating systems are permitted, provided they comply with the following:
 - C.29.1.5.1.** The auxiliary heating system shall utilize the same type fuel as specified for the vehicle engine.
 - C.29.1.5.2.** The heater(s) may be direct, hot air-type or may be connected to the engine coolant system.
 - C.29.1.5.3.** An auxiliary heating system, when connected to the engine coolant system, may be used to preheat the engine coolant or preheat and add supplementary heat to the heating system.
 - C.29.1.5.4.** Auxiliary heating systems must be installed pursuant to the manufacturer's recommendations and shall not direct exhaust in such a manner that will endanger bus passengers.
 - C.29.1.5.5.** All combustion heaters shall be in compliance with current Federal Motor Carrier Safety Regulations.
 - C.29.1.5.6.** The auxiliary heating system shall require low voltage.
 - C.29.1.5.7.** Auxiliary heating systems shall comply with FMVSS No. 301, Fuel System Integrity, and all other applicable FMVSS's, as well as with SAE test procedures.
- C.29.1.6.** All forced-air heaters installed by body manufacturers shall bear a name plate that indicates the heater rating in accordance with SBMTC-001, Standard Code for Testing and Rating Automotive Bus Hot Water Heating and Ventilating Equipment. The plate shall be affixed by the heater manufacturer and shall constitute certification that the heater performance is as shown on the plate.
- C.29.1.7.** Heater hoses shall be adequately supported to guard against excessive wear due to vibration. The hoses shall not dangle or rub against the chassis or any sharp edges and shall not interfere with or restrict the operation of any engine function. Heater hoses shall conform to SAE J20c, Coolant System Hoses. Heater lines on the interior of the bus shall be shielded to prevent scalding of the driver or passengers.
- C.29.1.8.** Each hot water system installed by a body manufacturer shall include one shutoff valve in the pressure line and one shut-off valve in the return line with both valves at the engine in an accessible location, except that on Types A and B buses the valves may be installed in another accessible location.
- C.29.1.9.** All heaters in the passenger compartment shall be equipped with a device, installed in the hot water pressure line, which regulates the water flow to all passenger heaters. The device shall be conveniently operated by the driver while seated. The driver and passenger heaters may operate independently of each other for maximum comfort.
- C.29.1.10.** Accessible bleeder valves for removing air from the heater shall be installed in an appropriate place in the return lines of body company installed heater.
- C.29.1.11.** Access panels shall be provided to make heater motors, cores and fans readily accessible for service. An exterior access panel to the driver's heater may be provided.

C.30. HINGES

- C.30.1.** All exterior metal door hinges shall be designed to allow lubrication to be channeled to the center 75% of each hinge loop without disassembly, unless they are constructed of stainless steel, brass or non-metallic hinge pins or other designs that prevent corrosion.

C.31. HORN

C.31.1. The bus shall be equipped with a horn(s) of standard make with the horn(s) capable of producing a complex sound in bands of audio frequencies between 250 and 2,000 cycles per second and tested in accordance with SAE J377, *Horn—Forward Warning—Electric—Performance, Test, and Application*.

C.32. IDENTIFICATION

C.32.1. The body shall bear the words "SCHOOL BUS" in black letters at least eight inches high on both front and rear of the body or on signs attached thereto. Lettering shall be placed as high as possible without impairment of its visibility. Letters shall conform to "Series B" of Standard Alphabets for Highway Signs. "SCHOOL BUS" lettering shall have a reflective background or, as an option, may be illuminated by backlighting. MFSABs are exempt from these requirements.

C.32.2. Required lettering and numbering shall include:

C.32.2.1. District, company name or owner of the bus displayed at the beltline.

C.32.2.2. The bus identification number displayed on the sides, on the rear and on the front.

C.32.2.3. The vehicles seating capacity, GVWR, and height, which shall be placed in a conspicuous exterior location on the driver's entry side of the bus close enough to the entry door for the driver to easily see the information.

C.32.2.3.1. Lettering will be in 2" block letters.

C.32.2.3.2. The height of the bus will be measured to the highest part of the bus including all accessories except antennas.

C.32.2.3.3. The height specified may be greater than the actual height of the bus provided it is not more than 6" higher than the actual height.

C.32.3. Other lettering, numbering or symbols which may be displayed on the exterior of the bus shall be limited to:

C.32.3.1. Bus identification number, minimum 12-inch high characters, on top of the bus, in addition to required numbering on the sides, rear and front;

C.32.3.2. The location of the battery(ies) identified by the word "BATTERY" or "BATTERIES" on the battery compartment door in two inch lettering;

C.32.3.3. Symbols or letters not to exceed 64 square inches of total display near the entrance door displaying information for identification by the students of the bus or route served;

C.32.3.4. Manufacturer, dealer or school identification or logos;

C.32.3.5. Symbols identifying the bus as equipped for or transporting students with special needs as noted in SPECIALLY EQUIPPED SCHOOL BUS SPECIFICATIONS;

C.32.3.6. Lettering on the rear of the bus relating to school bus flashing signal lamps or railroad stop procedures; and

C.32.3.7. Identification of fuel type in 2-inch lettering adjacent to the fuel filler opening.

C.33. INSIDE HEIGHT

C.33.1. Inside body height shall be 72 inches or more, measured metal to metal, at any point on the longitudinal centerline from the front vertical bow to the rear vertical bow. Inside body height of Type A-1 buses shall be 62 inches or more. Inside height measurement does not apply to air conditioning equipment.

C.34. INSTRUMENTS AND INSTRUMENT PANEL

C.34.1. The chassis shall be equipped with the instruments and gauges listed below: (Telltale warning lamps in lieu of gauges are not acceptable, except as noted.)

C.34.1.1. Speedometer;

C.34.1.2. Odometer that can be read without using a key and that will give accrued mileage (to seven digits), including tenths of miles unless tenths of miles are registered on a trip odometer.

- C.34.1.3. Tachometer (Note: For types B, C and D buses, a tachometer shall be installed so as to be visible to the driver while seated in a normal driving position.);
- C.34.1.4. Voltmeter (Note: An ammeter with graduated charge and discharge indications is permitted in lieu of a voltmeter; however, when used, the ammeter wiring must be compatible with the current flow of the system.);
- C.34.1.5. Oil pressure gauge;
- C.34.1.6. Water temperature gauge;
- C.34.1.7. Fuel gauge;
- C.34.1.8. High beam headlamp indicator;
- C.34.1.9. Brake air pressure gauge (air brakes), brake indicator lamp (vacuum/ hydraulic brakes), or brake indicator lamp (hydraulic/hydraulic);
- C.34.1.10. Turn signal indicator; and
- C.34.1.11. Glow-plug indicator lamp, where appropriate.
- C.34.2. All instruments shall be easily accessible for maintenance and repair.
- C.34.3. The instruments and gauges shall be mounted on the instrument panel so that each is clearly visible to the driver while seated in a normal driving position.
- C.34.4. Instruments and controls must be illuminated as required by FMVSS No. 101, *Controls and Displays*.
- C.34.5. Multi-function gauge (MFG)
 - C.34.5.1. The driver must be able to manually select any displayable function of the gauge on a MFG, whenever desired.
 - C.34.5.2. Whenever an out-of-limits condition that would be displayed on one or more functions of a MFG occurs, the MFG controller should automatically display this condition on the instrument cluster. This should be in the form of an illuminated telltale warning lamp, as well as having the MFG automatically display the out-of-limits indications. If two or more functions displayed on the MFG go out of limits simultaneously, then the MFG should sequence automatically between those functions continuously until the condition(s) are corrected.
 - C.34.5.3. The use of an MFG does not relieve the need for audible warning devices where required.

C.35. INTERIOR

- C.35.1. The interior of the bus shall be free of all unnecessary projections, which include luggage racks and attendant handrails, to minimize the potential for injury. This specification requires inner lining on ceilings and walls. If the ceiling is constructed with lap joints, the forward panel shall be lapped by rear panel, and exposed edges shall be beaded, hemmed, flanged or otherwise treated to minimize sharp edges. Buses may be equipped with a storage compartment for tools, tire chains, and/or tow chains. (See BUS BODY AND BODY SPECIFICATIONS, Storage Compartment.) MFSABs may use luggage racks provided they meet the requirements of FMVSS 222.
- C.35.2. Interior overhead storage compartments may be provided if they meet the following criteria:
 - C.35.2.1. Head protection requirements of FMVSS No. 222, *School Bus Passenger Seating and Crash Protection*, where applicable;
 - C.35.2.2. Completely enclosed and equipped with latching door (both door and latch sufficient to withstand a pushing force of 50 pounds applied at the inside center of the door);
 - C.35.2.3. All corners and edges rounded with a minimum radius of one inch or be padded equivalent to door header padding;
 - C.35.2.4. Attached to the bus sufficiently to withstand a force equal to 20 times the maximum rated capacity of the compartment; and
 - C.35.2.5. No protrusions greater than ¼ inch.

- C.35.3. The driver's area forward of the foremost padded barriers will permit the mounting of required safety equipment and vehicle operation equipment.
- C.35.4. Every school bus shall be constructed so that the noise level at the ear of the occupant nearest to the primary vehicle noise source shall not exceed 85 DBA when tested according to the procedure described in APPENDIX.
- C.35.5. On C and D type buses at least the front two ceiling sections of the bus will be perforated to increase noise absorption.

C.36. LAMPS AND SIGNALS

- C.36.1. Interior lamps which illuminate the aisle and the stepwell shall be provided. The stepwell lamp shall be illuminated by an entrance door-operated switch to illuminate only when headlamps and clearance lamps are on and the entrance door is open.
- C.36.2. Body instrument panel lamps may be controlled by an independent dimmer switch or may be controlled by the dimmer that operates the gauge lighting.
- C.36.3. School bus alternately flashing signal lamps shall be provided as described by law. MFSAB's are exempt from this requirement.
 - C.36.3.1. The bus shall be equipped with two red lamps at the rear of the vehicle and two red lamps at the front of the vehicle.
 - C.36.3.2. In addition to the four red lamps described above, four amber lamps shall be installed so that one amber lamp is located near each red signal lamp at the same level but closer to the vertical centerline of the bus. The system of red and amber signal lamps shall be wired so that amber lamps are energized manually. The red lamps are automatically energized and amber lamps are automatically de-energized when stop signal arms are extended or when the bus entrance door is opened. The above mentioned activation sequence can be accomplished with either a "sequential operation" or a "non-sequential operation" warning lamp system. While each of the systems can be configured to include components such as a master switch, amber activation switch, interrupt switch, etc., the presence (or absence) of these components does not affect the classification of the system as either *sequential* or *non-sequential*. Both *sequential* and *non-sequential* systems can be configured with a multitude of switch combinations to provide a unique system meeting specific user requirements. An amber pilot lamp and a red pilot lamp shall be installed adjacent to the driver controls for the flashing signal lamp to indicate to the driver which lamp system is activated.
 - C.36.3.3. In buses with power doors, the driver shall be able to activate the red signal lamp prior to opening the door. This is accomplished by having a door switch that has three positions. The first is closed. The second position is red warning lights engaged and amber lights off with the service door closed. The third position is red warning lights on and service door open.
 - C.36.3.4. For background color requirements, refer to "Color."
 - C.36.3.5. Red lamps shall flash at any time the stop signal arm is extended.
 - C.36.3.6. All flashers for alternately flashing red and amber signal lamps shall be enclosed in the body in a readily accessible location.
- C.36.4. Turn signal and stop/tail lamps
 - C.36.4.1. The bus body shall be equipped with amber rear turn signal lamps that are at least seven inches in diameter or, if a shape other than round, a minimum 38 square inches of illuminated area and shall meet FMVSS No. 108, *Lamps, Reflective Devices, and Associated Equipment*. These signal lamps must be connected to the chassis hazard warning switch to cause simultaneous flashing of turn signal lamps when needed as a vehicular traffic hazard warning. Turn signal lamps are to be placed as wide apart as practical, and their horizontal centerline shall be a maximum of 12 inches below the rear window.
 - C.36.4.2. Buses shall be equipped with amber side-mounted turn signal lamps. The turn signal lamp on the left side shall be mounted rearward of the stop signal arm and the turn signal lamp on the right side shall be mounted rearward of the entrance door.
 - C.36.4.3. Buses shall be equipped with four combination red stop/tail lamps.

- C.36.4.3.1. Two combination lamps with a minimum diameter of seven inches, or if a shape other than round, a minimum 38 square inches of illuminated area shall be mounted on the rear of the bus just inside the turn signal lamps.
- C.36.4.3.2. Two combination lamps with a minimum diameter of four inches, or if a shape other than round, a minimum of 12 square inches of illuminated area shall be placed on the rear of the body between the beltline and the floor line. The rear license plate lamp may be combined with one lower tail lamp. Stop lamps shall be activated by the service brakes and shall emit a steady light when illuminated.
- C.36.5. On buses equipped with a monitor for the front and rear lamps of the school bus, the monitor shall be mounted in full view of the driver. If the full circuit current passes through the monitor, each circuit shall be protected against any short circuit or intermittent shorts by a fuse circuit breaker, or electronic protection device.
- C.36.6. An optional white flashing strobe lamp may be installed on the roof of a school bus at a location not to exceed 1/3 the body length forward from the rear of the roof edge. The lamp shall have a single clear lens emitting light 360 degrees around its vertical axis and it may not extend above the roof more than the maximum legal height. A manual switch and a pilot lamp shall be included to indicate when the lamp is in operation. Optionally, the strobe lamp may be mounted on the roof in the area directly over the restraining barrier on the driver's side; may be wired to activate with the amber alternately flashing signal lamps, continuing through the full loading or unloading cycle; and may be equipped with an override switch to allow activation of the strobe at any time for use in inclement weather.
- C.36.7. The bus body shall be equipped with two white rear backup lamps that are at least four inches in diameter or, if a shape other than round, a minimum of 12 square inches of illuminated area and shall meet FMVSS No. 108. If backup lamps are placed on the same horizontal line as the brake lamps and turn signal lamps, they shall be to the inside.
- C.36.8. A daytime running lamps (DRL) system shall be provided.
- C.36.9. All body signaling lights including red and amber flashers shall be LED. Back-up lights may be LED.

C.37. METAL TREATMENT

- C.37.1. All metal except high-grade stainless steel or aluminum used in construction of the bus body shall be zinc-coated or aluminum-coated or treated to prevent corrosion. This includes, but is not limited to, such items as structural members, inside and outside panels, door panels, and floor sills. Excluded are such items as door handles, grab handles, interior decorative parts, and other interior plated parts.
- C.37.2. All metal parts that will be painted, in addition to the above requirements, shall be chemically cleaned, etched, zinc phosphate-coated, and zinc chromate or epoxy primed to improve paint adhesion. This includes, but is not limited to, such items as crossing control arm and stop arm.
- C.37.3. In providing for these requirements, particular attention shall be given to lapped surfaces, welded connections of structural members, cut edges on punched or drilled hole areas in sheet metal, closed or box sections, un-vented or un-drained areas, and surfaces subjected to abrasion during vehicle operation.
- C.37.4. As evidence that the above requirements have been met, samples of materials and sections used in the construction of the bus body shall be subjected to cyclic corrosion testing as outlined in SAE J1563.

C.38. MIRRORS

- C.38.1. The interior glass mirror shall be either laminated or tempered and shall have rounded corners and protected edges. Mirrors shall be 6x16 inches minimum for Type A buses and 6x30 inches minimum for Types C and D buses.
- C.38.2. Each school bus shall be equipped with exterior mirrors meeting the requirements of FMVSS No. 111, *Rearview Mirrors*. The right side rear view mirror shall not be obscured by the unwiped portion of the windshield. Mirrors shall be easily adjustable but shall be rigidly braced to reduce vibration.
- C.38.3. Heated external mirrors shall be used.

C.38.4. Remote controlled external rear view mirrors shall be used.

C.39. MOUNTING

C.39.1. The rear body cross member shall be supported by the chassis frame. Except where chassis components interfere, the bus body shall be attached to the chassis frame at each main floor sill in such a manner as to prevent shifting or separation of the body from the chassis under severe operating conditions.

C.39.2. Isolators shall be installed at all contact points between the body and the chassis frame on Types A-2, B, C and D buses and shall be secured by a positive means to the chassis frame or body to prevent shifting, separation, or displacement of the isolators under severe operating conditions.

C.40. OIL FILTER

C.40.1. An oil filter with a replaceable element shall be provided and connected by flexible oil lines if it is not a built-in or an engine-mounted design. The oil filter shall have a capacity in accordance with the engine manufacturer's recommendation.

C.41. OPENINGS

C.41.1. All openings in the floorboard or firewall between the chassis and the passenger compartment (e.g., for gearshift selector and parking brakes lever) shall be sealed.

C.42. OVERALL LENGTH

C.42.1. Overall length of the bus shall not exceed 45 feet, excluding accessories.

C.43. OVERALL WIDTH

C.43.1. Overall width of bus shall not exceed 102 inches, excluding accessories.

C.44. PASSENGER LOAD

C.44.1. Actual gross vehicle weight (GVW) is the sum of the chassis weight plus the body weight, plus the driver's weight, plus total seated student weight. For purposes of calculation, the driver's weight is 150 pounds and the student weight is 120 pounds per student.

C.44.2. Actual GVW shall not exceed the chassis manufacturer's GVWR for the chassis, nor shall the actual weight carried on any axle exceed the chassis manufacturer's Gross Axle Weight Rating (GAWR).

C.45. PUBLIC ADDRESS SYSTEM

C.45.1. Buses may be equipped with an AM/FM/audio and/or public address system having interior and exterior speakers.

C.45.2. No internal speakers, other than the driver's communication systems, may be installed within four feet of the driver's seat back in its rearmost upright position.

C.46. RETROREFLECTIVE MATERIAL

See also APPENDIX, Retroreflective Sheeting and APPENDIX A in National School Transportation Specifications and Procedures 2010)

C.46.1. The front and/or rear bumper may be marked diagonally 45 degrees down toward the centerline of the pavement with two \pm ¼-inch wide strips of non-contrasting retroreflective material.

C.46.2. The rear of the bus body shall be marked with strips of retroreflective NSBY material to outline the perimeter of the back of the bus using material which conforms with the requirements of FMVSS No. 131, *School Bus Pedestrian Safety Devices*, Table 1. The perimeter marking of rear emergency exits per FMVSS No. 217, *Bus Emergency Exits and Window Retention and Release*, and/or the use of retroreflective "SCHOOL BUS" signs partially accomplishes the objective of this requirement. To complete the perimeter marking of the back of the bus, strips of retroreflective NSBY material, a minimum of one inch and a maximum of two inches in width, shall be applied horizontally above the rear windows and above the rear bumper, extending from the rear emergency exit perimeter and marking outward to the left and right rear corners of the bus. Vertical strips shall be applied at the corners connecting these horizontal strips.

- C.46.3. "SCHOOL BUS" signs, if not a lighted design, shall be marked with retroreflective NSBY material comprising background for lettering of the front and/or rear "SCHOOL BUS" signs.
- C.46.4. Sides of the bus body shall be marked with at least 1¾-inch retroreflective NSBY material, extending the length of the bus body and located (vertically) between the floor line and the beltline.
- C.46.5. If used, signs placed on the rear of the bus relating to school bus flashing signal lamps or railroad stop procedures may be retroreflective material as specified by each state.

C.47. ROAD SPEED CONTROL

- C.47.1. When accurate control of vehicle maximum speed is desired, a vehicle speed limiter may be utilized.

C.48. RUB RAILS

- C.48.1. There shall be one rub rail on each side of the bus located at, or no more than eight inches above, the seat cushion level. They shall extend from the rear side of the entrance door completely around the bus body (except at the emergency door or any maintenance access door) to the point of curvature near the outside cowl on the left side.
- C.48.2. There shall be one additional rub rail on each side located 10 inches or less above the floor line. The rub rail shall cover the same longitudinal span as the upper rub rail, except at the wheel housing, and it shall extend only to the longitudinal tangent of the right and left rear corners.
- C.48.3. Rub rails above the floor line shall be attached at each body post and at all other upright structural members.
- C.48.4. Each rub rail shall be four inches or more in width in its finished form and shall be constructed of 16-gauge metal or other material of equivalent strength suitable to help protect body side panels from damage. Rub rails shall be constructed in corrugated or ribbed fashion.
- C.48.5. Rub rails shall be applied outside the body or outside the body posts. (Pressed-in or snap-on rub rails do not satisfy this requirement.) For Type A-1 vehicles using the body provided by the chassis manufacturer or for Types A-2, B, C and D buses containing the rear luggage or the rear engine compartment, rub rails need not extend around the rear corners.
- C.48.6. The bottom edge of the body side skirts shall be stiffened by application of a rub rail, or the edge may be stiffened by providing a flange or other stiffeners.

C.49. SEATS AND RESTRAINING BARRIERS

C.49.1. Passenger Seating

- C.49.1.1. School bus design capacities shall be in accordance with 49 CFR, Part 571.3, Definitions, and FMVSS No. 222, School Bus Passenger Seating and Crash Protection.
- C.49.1.2. All seats shall have a minimum cushion depth of 15 inches and a seat back height of 24 inches above the seating reference point and must comply with all other requirements of FMVSS No. 222.
- C.49.1.3. All restraining barriers and passenger seats shall be constructed with materials that enable them to meet the criteria of the *School Bus Seat Upholstery Fire Block Test*.
- C.49.1.4. Each seat leg shall be secured to the floor by a minimum of two bolts, washers and nuts. Flange-head nuts may be used in lieu of nuts and washers. All seat frames attached to the seat rail shall be fastened with two or more bolts, washers and nuts or with flange-head nuts. Seats may be track-mounted in conformance with FMVSS No. 222.
- C.49.1.5. If track seating is installed, the manufacturer shall supply minimum and maximum seat spacing dimensions (applicable to the bus) which comply with FMVSS No. 222. This information shall be on a label permanently affixed to the bus.
- C.49.1.6. All school buses (including Type A) shall be equipped with restraining barriers which conform to FMVSS No. 222.
- C.49.1.7. A flip-up seat may be installed at any side emergency door. If provided, the flip-up seat shall conform to FMVSS No. 222 and aisle clearance requirements of FMVSS No. 217, *Bus Emergency Exits and Window Retention and Release*. The flip-up seat shall be free of sharp

projections on the underside of the seat bottom. The underside of the flip-up seat bottoms shall be padded or contoured to reduce the possibility of clothing being snagged. Flip-up seats shall be constructed to prevent passenger limbs from becoming entrapped between the seat back and the seat cushion when the seat is in the upright position. The seat cushion shall be designed to rise to a vertical position automatically when it is not occupied.

C.49.1.8. Lap belts shall not be installed on passenger seats in large school buses (over 10,000 pounds GVWR) except in conjunction with child safety restraint systems that comply with the requirements of FMVSS No. 213, Child Restraint Systems.

C.49.2. Pre-School Age Seating

C.49.2.1. Passenger seats designed to accommodate a child or infant carrier seat shall comply with FMVSS No. 225, *Child Restraint Anchorage Systems*. These seats shall be in compliance with NHTSA's "Guideline for the Safe Transportation of Pre-school Age Children in School Buses." (Note: See A.8, above.)

C.49.3. Driver Seat

C.49.3.1. The driver's seat supplied by the body manufacturer shall be a high back seat. The seat back shall be adjustable to 15 degrees minimum without requiring the use of tools. The seat shall be equipped with a head restraint to accommodate a 5th percentile female to a 95th percentile adult male as defined in FMVSS No. 208, *Occupant Crash Protection*.

C.49.3.2. Type A buses may utilize the standard driver's seat provided by the chassis manufacturer.

C.49.4. Driver Restraint System

C.49.4.1. A Type 2 lap/shoulder belt shall be provided for the driver. On buses where the driver's seat and upper anchorage for the shoulder belt are both attached to the body structure, a driver's seat with an integrated Type 2 lap/shoulder belt may be substituted. On buses where the driver's seat and upper anchorage for the shoulder belt are separately attached to both body and chassis structures (i.e., one attached to the chassis and the other attached to the body), a driver's seat with an integrated Type 2 lap/shoulder belt should be used.

The assembly shall be equipped with an emergency locking retractor for the continuous belt system. On all buses except Type A that are equipped with a standard chassis manufacturer's driver's seat, the lap portion of the belt system shall be guided or anchored to prevent the driver from sliding sideways under the belt system. The lap/shoulder belt shall be designed to allow for easy adjustment in order to fit properly and to effectively protect drivers varying in size from 5th percentile adult female to 95th percentile adult male.

C.49.5. Each bus shall be equipped with a durable webbing cutter having a full width handgrip and a protected, replaceable or non-corrodible blade. The required webbing cutter shall be mounted in a location accessible to the seated driver in an easily detachable manner.

C.50. SHOCK ABSORBERS

C.50.1. The bus shall be equipped with double-action shock absorbers compatible with the manufacturer's rated axle capacity at each wheel location.

C.51. SIDE SKIRTS

C.51.1. School bus body side skirts between the front and rear axles shall extend down to within two inches, plus or minus, of the horizontal line from the center of the front spindle to the center of the rear axle. The manufacturer may offer optional side skirt lengths that extend lower than this requirement. This measurement shall apply to a new unloaded school bus located on a flat, level surface.

C.52. STEERING GEAR

C.52.1. The steering gear shall be approved by the chassis manufacturer and designed to ensure safe and accurate performance when the vehicle is operated with maximum load and at maximum speed.

C.52.2. If external adjustments are required, the steering mechanism shall be accessible to make adjustments.

- C.52.3. Changes shall not be made to the steering apparatus which are not approved by the chassis manufacturer.
- C.52.4. There shall be a clearance of at least two inches between the steering wheel and cowl, instrument panel, windshield or any other surface.
- C.52.5. Power steering is required and shall be of the integral type with integral valves.
- C.52.6. The steering system shall be designed to provide a means for lubrication of all wear-points that are not permanently lubricated. The steering column shall be telescoping or tilting or both to accommodate a wide range of drivers.

C.53. STEPS

- C.53.1. The first step at the entrance door shall be not less than 10 inches and not more than 14 inches from the ground when measured from the top surface of the step to the ground, based on standard chassis specifications. Exception: On Type D vehicles, the first step at the entrance door shall be 12 inches to 16 inches from the ground. An auxiliary step may be provided to compensate for the increase in ground-to-first-step clearance. The auxiliary step is not required to be enclosed.
- C.53.2. Step risers shall not exceed a height of 10 inches. Exception: When plywood is used on a steel floor or step, the riser height may be increased by the thickness of the plywood.
- C.53.3. Steps shall be enclosed to prevent accumulation of ice and snow.
- C.53.4. Steps shall not protrude beyond the side body line.

C.54. STEP TREADS

- C.54.1. All steps, including the floor line platform area, shall be covered with an elastomer floor covering having a minimum overall thickness of 0.187 inch.
- C.54.2. The step covering shall be permanently bonded to a durable backing material that is resistant to corrosion.
- C.54.3. Steps, including the floor line platform area, shall have a 1½-inch nosing that contrasts in color by at least 70 percent measured in accordance with the contrasting color specification in 36 CFR, Part 1192, ADA, *Accessibility Guidelines for Transportation Vehicles*.
- C.54.4. Step treads shall have the following characteristics:
 - C.54.4.1. Abrasion resistance: Step tread material weight loss shall not exceed 0.40 percent, as tested under ASTM D-4060, *Standard Test Method for Abrasion Resistance of Organic Coatings by the Taber Abraser*, (CS-17 Wheel, 1000 gram, 1000 cycle).
 - C.54.4.2. Weathering resistance: Step treads shall not break, crack, or check after ozone exposure (seven days at 50 phm at 40 degrees C) and Weatherometer exposure (ASTM D-750, *Standard Test Method for Rubber Deterioration in Carbon-Arc Weathering Apparatus*, seven days).
 - C.54.4.3. Flame resistance: Step treads shall have a calculated burn rate of .01 or less using the test methods, procedures and formulas listed in FMVSS No. 302, *Flammability of Interior Materials*.

C.55. STIRRUP STEPS

- C.55.1. If the windshield and lamps are not easily accessible from the ground, there may be at least one folding stirrup step or recessed foothold installed on each side of the front of the body for easy accessibility for cleaning. There also may be a grab handle installed in conjunction with the step. Steps are permitted in or on the front bumper in lieu of the stirrup steps if the windshield and lamps are easily accessible for cleaning from that position.

C.56. STOP SIGNAL ARM

- C.56.1. The stop signal arm(s) shall comply with the requirements of FMVSS No. 131, *School Bus Pedestrian Safety Devices*. Stop signal arm lights shall use LEDs. MFSABs are exempt from these requirements.

C.57. SUN SHIELD

- C.57.1.** On Types B, C and D vehicles, an interior adjustable transparent sun shield, with a finished edge and dimensions not less than 6x30 inches, shall be installed in a position convenient for use by the driver.
- C.57.2.** On Type A buses, the sun shield (visor) shall be installed by the chassis manufacturer.

C.58. SUSPENSION SYSTEMS

- C.58.1.** The capacity of springs or suspension assemblies shall be commensurate with the chassis manufacturer's GVWR.
- C.58.2.** Rear leaf springs shall be of a progressive rate or multi-stage design. Front leaf springs shall have a stationary eye at one end and shall be protected by a wrapped leaf in addition to the main leaf.

C.59. THROTTLE

- C.59.1.** The force required to operate the throttle shall not exceed 16 pounds throughout the full range of accelerator pedal travel.

C.60. TIRES AND RIMS

- C.60.1.** Rims and tires of the proper size and load rating commensurate with the chassis manufacturer's GVWR shall be provided. The use of multi-piece rims and/or tube-type tires shall not be permitted on any school bus ordered after December 31, 1995.
- C.60.2.** Dual rear tires shall be provided on Type A-2, Type B, Type C and Type D school buses.
- C.60.3.** All tires on a vehicle shall be of the same size, and the load range of the tires shall meet or exceed the GVWR, as required by FMVSS No. 120, *Tire Selection and Rims for Vehicles other than Passenger Car*.
- C.60.4.** If the vehicle is equipped with a spare tire and rim assembly, it shall be the same size as those mounted on the vehicle.
- C.60.5.** If a tire carrier is required, it shall be suitably mounted in an accessible location outside of the passenger compartment.

C.61. TOWING ATTACHMENT POINTS

- C.61.1.** Two (2) front and two (2) rear towing devices (i.e., tow hooks, tow eyes, or other designated towing attachment points) shall be furnished to assist in the retrieval of buses that are stuck and/or for towing buses when a wrecker with a "wheel lift" or an "axle lift" is not available or cannot be applied to the towed vehicle.
 - C.61.1.1.** Towing devices shall be attached to the chassis frame either by the chassis manufacturer or in accordance with the chassis manufacturer's specifications.
 - C.61.1.2.** Each towing device shall have a strength rating of 13,500 pounds each for a combined rating of 27,000 pounds with the force applied in the rearward direction, parallel to the ground, and parallel to the longitudinal axis of the chassis frame rail. For pulling and lifting purposes, tow hooks are meant to be used simultaneously. For pulling, angularity applied to the tow hooks will decrease the capacities of the tow hooks.
 - C.61.1.3.** The towing devices shall be mounted such that they do not project forward of the front bumper or rearward of the rear bumper.

Note: Type A buses are exempt from the requirement for front tow hooks or eyes due to built-in crush zones.

C.62. TRANSMISSION

- C.62.1.** Automatic transmissions shall have no fewer than three forward speeds and one reverse speed. Mechanical shift selectors shall provide a detent between each gear position when the gear selector quadrant and shift selector are not steering column mounted.
- C.62.2.** Automatic transmissions incorporating a parking pawl shall have a transmission shifter interlock controlled by the application of the service brake to prohibit accidental engagement of the

transmission. All non-park pawl transmissions shall incorporate a park brake interlock that requires the service brake to be applied to allow release of the parking brake.

C.62.3. Transmissions will be automatic.

C.63. TURNING RADIUS

C.63.1. A chassis with a wheelbase of 264 inches or less shall have a right and left turning radius of not more than 42½ feet, curb-to-curb measurement.

C.63.2. A chassis with a wheelbase of 265 inches or more shall have a right and left turning radius of not more than 44½ feet, curb-to-curb measurement.

C.64. UNDERCOATING

C.64.1. The entire underside of the bus body, including floor sections, cross member and below floor-line side panels, shall be coated with rust-proofing material for which the material manufacturer has issued a notarized certification to the bus body manufacturer that materials meet or exceed all performance requirements of SAE J1959.

C.64.2. The undercoating material shall be applied with suitable airless or conventional spray equipment to the undercoating material manufacturer recommended film thickness and shall show no evidence of voids in the cured film. The undercoating material shall not cover any exhaust components of the chassis.

C.65. VENTILATION

C.65.1. Auxiliary fans shall meet the following requirements:

C.65.1.1. Fans for left and right sides of the windshield shall be placed in a location where they can be adjusted for maximum effectiveness and where they do not obstruct vision to any mirror.
Note: Type A buses may be equipped with one fan.

C.65.1.2. Fans shall have six-inch (nominal) diameter.

C.65.1.3. Fan blades shall be enclosed in a protective cage. Each fan shall be controlled by a separate switch.

C.65.2. The bus body shall be equipped with a suitably controlled ventilating system with capacity sufficient to maintain the proper quantity of air flow under operating conditions without having to open a window except in extremely warm weather.

C.65.3. Static-type, non-closeable exhaust ventilation shall be installed in a low-pressure area of the roof.

C.65.4. Roof hatches designed to provide ventilation in all types of exterior weather conditions may be provided.

C.66. WHEELHOUSING

C.66.1. The wheelhousing opening shall allow for easy tire removal and service.

C.66.2. Wheel housings shall be attached to the floor panels in a manner to prevent any dust, water or fumes from entering the body. Wheel housings shall be constructed of 16- gauge (or thicker) steel.

C.66.3. The inside height of the wheel housings above the floor line shall not exceed 12 inches.

C.66.4. The wheel housings shall provide clearance for installation and use of tire chains on single or dual (if so equipped) power-driving wheels.

C.66.5. No part of a raised wheelhousing shall extend into the emergency door opening.

C.67. WINDOWS

C.67.1. Other than emergency exits designated to comply with FMVSS No. 217, *Bus Emergency Exits and Window Retention and Release*, each side window shall provide an unobstructed opening of at least nine inches high (but not more than 13 inches high) and at least 22 inches wide, obtained by lowering the window. One window on each side of the bus may be less than 22 inches wide.

C.67.2. Passenger compartment glass shall be tinted with approximate 28% light transmission.

C.67.3. Frost-free glazing may be installed in all doors or windows.

C.67.4. Windshields shall comply with federal, state and local regulations.

C.68. WINDSHIELD WASHERS

C.68.1. A windshield washer system shall be provided.

C.69. WINDSHIELD WIPERS

C.69.1. A two-speed or variable speed windshield wiping system, with an intermittent feature, shall be provided and shall be operated by a single switch.

C.69.2. The wipers shall meet the requirements of FMVSS No. 104, *Windshield Wiping and Washing Systems*.

The following requirements are Optional.

C.70. FIRE SUPPRESSION SYSTEMS (OPTIONAL)

C.70.1. The chassis manufacturer may provide an automatic fire extinguisher system in the engine compartment.

C.70.2. Fire suppression system nozzles shall be located in the engine compartment, under the bus, in the electrical panel, or under the dash, but they shall not be located in the passenger compartment. The system must include a lamp or buzzer to alert the driver that the system has been activated.

C.71. Passenger Compartment Air Conditioning (Optional)

C.71.1.1. The following specifications are applicable to all types of school buses that may be equipped with air conditioning. This section is divided into three parts. Part 1 covers performance specifications, Part 2 covers test conditions and Part 3 covers other requirements applicable to all buses.

C.71.1.1.1. Performance Specifications

C.71.1.1.1.a Standard Performance:

The installed air conditioning system should cool the interior of the bus from 100 degrees to 80 degrees Fahrenheit measured at three points (minimum) located four feet above the floor on the longitudinal centerline of the bus. The three required points shall be: (1) three feet above the center point of the horizontal driver seat surface, (2) at the longitudinal midpoint of the body, and (3) three feet forward of the rear emergency door or, for Type D rear-engine buses, three feet forward of the end of the aisle. Note for the Type A vehicles placement of the rear thermocouple should be centered in the bus over the rear axle. The independent temperature reading of each temperature probe inside the bus shall be within a range of +/- 3 degrees Fahrenheit of the average temperature at the conclusion of the test.

C.71.1.1.1.b High Performance:

The installed air conditioning system should cool the interior of the bus from 100 degrees to 70 degrees Fahrenheit, measured at three points (minimum) located four feet above the floor on the longitudinal centerline of the bus. The three required points shall be: (1) three feet above the center point of the horizontal driver seat surface, (2) at the longitudinal midpoint of the body, and (3) three feet forward of the rear emergency door or, for Type D rear-engine buses, three feet forward of the end of the aisle. Note for the Type A vehicles placement of the rear thermocouple should be centered in the bus over the rear axle. The independent temperature reading of each temperature probe inside the bus shall be within a range of +/- 3 degrees Fahrenheit of the average temperature at the conclusion of the test.

C.71.1.1.2. Test Conditions

The test conditions under which the above performance standards must be achieved shall consist of (1) placing the bus in a room (such as a paint booth) where ambient temperature can be maintained at 100 degrees Fahrenheit; (2) heat-soaking the bus at 100 degrees Fahrenheit at a point measured two feet horizontally from the top of the windows on both sides of the bus with windows open for two hours; and (3) closing windows, turning on the air conditioner with the engine running at 1250 +/- 50 RPM, and cooling the interior of the bus to 80 degrees Fahrenheit (standard performance) or 70 degrees Fahrenheit (high performance) within 30 minutes while maintaining 100 degrees Fahrenheit outside temperature. The manufacturer shall provide facilities for the user or user's representative to confirm that a pilot model of each bus design meets the above performance requirements.

C.71.1.1.3. Other Requirements

C.71.1.1.3.a Evaporator cases, lines and ducting (as equipped) shall be designed in such a manner that all condensation is effectively drained to the exterior of the bus below the floor level under all conditions of vehicle movement and without leakage on any interior portion of the bus.

C.71.1.1.3.b Evaporators and ducting systems shall be designed and installed to be free of projections or sharp edges. Ductwork shall be installed so that exposed edges face the front of the bus and do not present sharp edges.

C.71.1.1.3.c On school buses equipped with Type-2 seatbelts having anchorages above the windows, the ducting (if used) shall be placed at a height sufficient not to obstruct occupant securement anchorages. This clearance shall be provided along the entire length (except at evaporator locations) of the passenger area on both sides of the bus interior.

C.71.1.1.3.d The body may be equipped with insulation, including sidewalls, roof, firewall, rear, inside body bows, and plywood or composite floor insulation to reduce thermal transfer.

C.71.1.1.3.e Electrical generating capacity shall be provided to accommodate the additional electrical demands imposed by the air conditioning system.

C.71.1.1.3.f Air intake for any evaporator assembly(ies), except for front evaporator of Type A-1, shall be equipped with replaceable air filter(s) accessible without disassembly of evaporator case.

C.71.1.1.3.g For all buses (except Type D rear engine transit) equipped with a rear evaporator assembly, evaporator shall not encroach upon head impact zone but may occupy an area of less than 26.5 inches from the rear wall and 14 inches from the ceiling.

C.71.1.1.3.h For Type D rear engine transit buses equipped with a rear evaporator over the davenport, the evaporator assembly may not interfere with rear exit window and may not extend above the rear Cseating row.

C.72. INSULATION (OPTIONAL)

C.72.1. If thermal insulation is specified, it shall be fire-resistant, UL approved, with minimum R-value of 5.5. Insulation shall be installed to prevent sagging.

C.72.2. If floor insulation is required, it shall be five-ply softwood plywood, nominal 5/8 inch thickness, and shall be equal to or exceed properties of the exterior-type, C-D Grade, as specified in the standard issued by U.S. Department of Commerce. When plywood is used, all exposed edges shall be sealed. Type A-1 buses may be equipped with nominal 1/2 inch-thick plywood or equivalent material meeting the above requirements. Equivalent material may be used to replace plywood provided it has equal or greater insulation R-value, sound abatement, deterioration-resistant, and moisture resistant properties.

C.73. RETARDER SYSTEM (OPTIONAL)

C.73.1. A retarder system, if used, shall limit the speed of a fully loaded school bus to 19.0 mph on a seven percent grade for 3.6 miles.

C.74. STORAGE COMPARTMENT (OPTIONAL)

C.74.1. A storage container for tools, tire chains, and other equipment may be located either inside or outside the passenger compartment. If inside, it shall be fastened to the floor and have a cover with a positive fastening device.

C.75. TRACTION ASSISTING DEVICES (OPTIONAL)

C.75.1. Where required or used, sanders shall:

C.75.1.1. Be hopper cartridge-valve type;

C.75.1.2. Have a metal hopper with all interior surfaces treated to prevent condensation of moisture;

C.75.1.3. Have at least 100 pounds (grit) capacity;

C.75.1.4. Have a cover that screws in place on the filler opening of the hopper, thereby sealing the unit airtight;

C.75.1.5. Have discharge tubes extending under the fender wheelhousing to the front of each rear wheel;

- C.75.1.6. Have non-clogging discharge tubes with slush-proof, non-freezing rubber nozzles;
- C.75.1.7. Be operated by an electric switch with a pilot lamp mounted on the instrument panel located so as to be exclusively controlled by the driver;
- C.75.1.8. Be equipped with a gauge to indicate that the hopper has reached the one quarter level (and needs to be refilled); and
- C.75.1.9. Be designed to prevent freezing of all activation components and moving parts.

C.75.2. Automatic traction chains may be installed.

C.76. TRASH CONTAINER AND HOLDING DEVICE (OPTIONAL)

- C.76.1. When requested or used, the trash container shall be secured by a holding device that is designed to prevent movement and to allow easy removal and replacement. It shall be installed in an accessible location in the driver's compartment, not obstructing passenger access to the entrance door.

The specifications listed below are for Specially Equipped School Buses. These specifications are Mandatory are in addition to the specifications listed in Section C.1 through C.69.

INTRODUCTION

Equipping buses to accommodate students with disabilities is dependent upon the needs of the passengers. While one bus may be fitted with a lift, another may have belts installed to secure child seats. Buses so equipped are not to be considered a separate class of school bus but simply a regular school bus that is equipped for special accommodations.

The specifications in this section are intended to supplement specifications in the BODY AND CHASSIS section. In general, specially equipped buses shall meet all the requirements of the preceding sections, plus those listed in this section. The field of special transportation is characterized by varied needs for individual cases and by rapidly emerging technologies for meeting individual student needs. A flexible, "common sense" approach to the adoption and enforcement of specifications for these vehicles, therefore, is prudent.

As defined by 49 Code of Federal Regulations (CFR) §571.3, "Bus means a motor vehicle with motive power, except a trailer, designed for carrying more than ten persons" (11 or more including the driver). This definition also embraces the more specific category, *school bus*. Vehicles with 10 or fewer occupant positions (including the driver) are not classified as buses. For this reason, the federal vehicle classification, *multipurpose passenger vehicle* (49 CFR § 571.3), or MPV, must be used by manufacturers for these vehicles in lieu of the classification *school bus*.

The definition of *designated seating position* in 49 CFR § 571.3 states that in the case of "vehicles sold or introduced into interstate commerce for purposes that include carrying students to and from school or related events" and which are "intended for securement of an occupied wheelchair during vehicle operations," each wheelchair securement position shall be counted as four designated seating positions when determining the classification (whether *school bus* or *MPV*). This classification system does not preclude state or local agencies or these national specifications from requiring compliance of school bus-type MPVs with the more stringent federal standards for school buses. The following specifications address modifications as they pertain to school buses that, with standard seating arrangements prior to modification, would accommodate eleven or more occupants including the driver. If by addition of a power lift, wheelchair positions or other modifications, the capacity is reduced such that vehicles become MPVs, the intent of these specifications is to require these vehicles to meet the same specifications they would have had to meet prior to such modifications, and such MPVs are included in all references to school buses and requirements for school buses which follow.

DEFINITION

A *specially equipped school bus* is any school bus that is designed, equipped and/or modified to accommodate students with special transportation needs.

C.77. GENERAL REQUIREMENTS

- C.77.1. Specially equipped school buses shall comply with the *National School Transportation Specifications and Procedures* and with the Federal Motor Vehicle Safety Standards (FMVSS) applicable to their Gross Vehicle Weight Rating (GVWR) category.
- C.77.2. Any school bus to be used for the transportation of children who utilize a wheelchair or other mobile positioning device, or who require life-support equipment that prohibits use of the regular service entrance, shall be equipped with a power lift, unless a ramp is needed for unusual circumstances related to passenger needs.

C.77.3. School bus bodies of this type shall meet all specifications as published in the Oklahoma Minimum Specifications for School Buses except for the modifications necessary for the installation of special equipment as listed herein.

C.78. AISLES

C.78.1. All school buses equipped with a power lift shall provide a minimum 30-inch pathway leading from any wheelchair position to at least one 30-inch wide emergency exit door. A wheelchair securement position shall never be located directly in front of (blocking) a power lift door location.

C.79. IDENTIFICATION

C.79.1. Specially equipped school buses shall display the International Symbol of Accessibility below the window line. Such emblems shall be white on blue or black background, shall not exceed 12 inches square in size, and shall be of a high-intensity retroreflective material meeting the requirements of Federal Highway Administration (FHWA) FP-85, *Standard Specifications for Construction of Roads and Bridges on Federal Highway Projects*.

C.80. PASSENGER CAPACITY RATING

C.80.1. In determining the passenger capacity of a school bus for purposes other than actual passenger load (e.g., vehicle classification or various billing/reimbursement models), any location in a school bus intended for securement of a wheelchair during vehicle operation shall be regarded as four designated seating positions, and each lift area shall count as four designated seating positions.

C.81. POWER LIFTS

C.81.1. The power lift shall be located on the right side of the bus body. Exception: The lift may be located on the left side of the bus if, and only if, the bus is used to deliver students only to the left side of one-way streets.

C.81.2. All specially equipped school buses shall provide a level-change mechanism or boarding device (e.g., lift or ramp), complying with this section or the RAMP section, with sufficient clearances to permit a wheelchair user to reach a securement location.

C.81.3. Vehicle lift and installation

C.81.3.1. General: Vehicle lifts and installations shall comply with the requirements set forth in FMVSS 403, *Platform Lift Systems for Motor Vehicles*, and FMVSS 404, *Platform Lift Installations in Motor Vehicles*.

C.81.3.2. Design loads: The design load of the lift shall be at least 800 pounds. Working parts, such as cables, pulleys and shafts, which can be expected to wear, and upon which the lift depends for support of the load, shall have a safety factor of at least six, based on the ultimate strength of the material. Non-working parts, such as platform, frame and attachment hardware that would not be expected to wear, shall have a safety factor of at least three, based on the ultimate strength of the material.

C.81.3.3. Lift capacity: The lifting mechanism and platform shall be capable of operating effectively with a wheelchair and occupant mass of at least 800 pounds.

C.81.3.4. Controls: (See 49 CFR 571.403, S6.7, *Control systems*.)

C.81.3.5. Emergency operations: (See 49 CFR 571.403, S6.9, *Backup operation*.)

C.81.3.6. Power or equipment failures: (See 49 CFR 571.403, S6.2.2, *Maximum platform velocity*.)

C.81.3.7. Platform barriers: (See 49 CFR 571.403, S6.4.7, *Wheelchair retention*.)

C.81.3.8. Platform surface: (See 49 CFR 571.403, S6.4.2, S6.4.3, *Platform requirements*.) (See also "Wheelchair or Mobility Aid Envelope" figure at the end of this subsection.)

C.81.3.9. Platform gaps and entrance ramps: (See 49 CFR 571.403, S6.4.4, *Gaps, transitions and openings*.)

C.81.3.10. Platform deflection: (See 49 CFR 571.403, S6.4.5, *Platform deflection*.)

C.81.3.11. Platform movement: (See 49 CFR 571.403, S6.2.3, *Maximum platform acceleration*.)

C.81.3.12. Boarding direction: The lift shall permit both inboard and outboard facing of wheelchair and mobility aid users.

C.81.3.13. Handrails: (See 49 CFR 571.403, S6.4.9, *Handrails*.)

C.81.3.14. Circuit breaker: A resettable circuit breaker shall be installed between the source and the lift motor if electrical power is used. It shall be located as close to the power source as possible but not within the passenger/driver compartment.

C.81.3.15. Excessive pressure: (See 49 CFR 571.403, S6.8, *Jacking prevention*.)

C.81.3.16. Documentation: The following information shall be provided with each vehicle equipped with a lift:

C.81.3.16.1. A phone number where information can be obtained about installation, repair and parts. (Detailed written instructions and a parts list shall be available upon request.)

C.81.3.16.2. Detailed instructions regarding use of the lift shall be readily visible when the lift door is open, including a diagram showing the proper placement and positioning of wheelchair/mobility aids on the lift.

C.81.3.16.3. Training materials: The lift manufacturer shall make training materials available to ensure the proper use and maintenance of the lift. These may include instructional videos, classroom curriculum, system test results or other related materials.

C.81.3.16.4. Identification and certification: Each lift shall be permanently and legibly marked or shall incorporate a non-removable label or tag that states it conforms to all applicable requirements of the current National School Transportation Specifications and Procedures. In addition and upon request of the original titled purchaser, the lift manufacturer or an authorized representative shall provide a notarized Certificate of Conformance, either original or photocopied, which states that the lift system meets all the applicable requirements of the current National School Transportation Specifications and Procedures.

Note: graphic of wheelchair or mobility aid envelope (Figure 1).

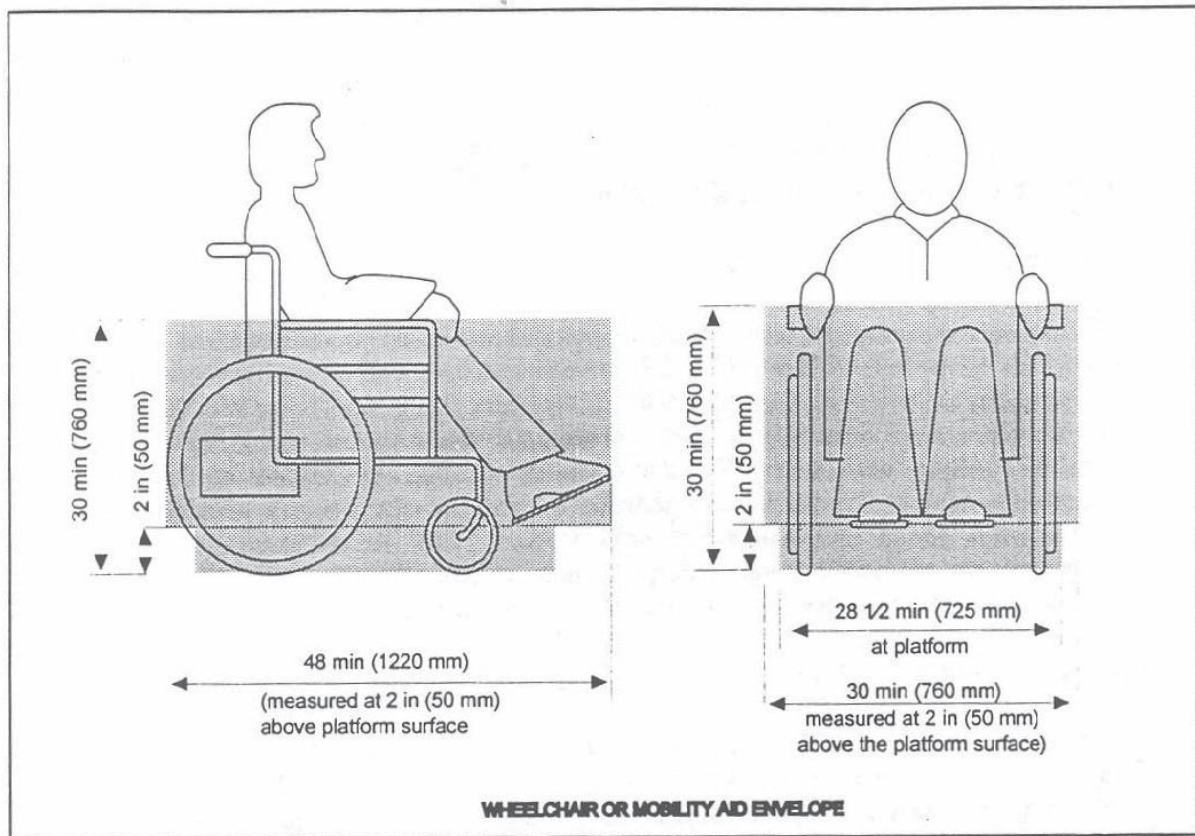

C.82. RAMPS

- C.82.1.** If a ramp is used, it shall be of sufficient strength and rigidity to support at least 800 pounds over an area of 26 x 26 inches. It shall be equipped with a protective flange on each longitudinal side to keep the special device on the ramp.
- C.82.2.** The surface of the ramp shall be constructed of non-skid material.
- C.82.3.** The ramp shall be equipped with handles and shall be of weight and design to permit one person to put the ramp in place and return it to its storage place. It shall be stored outside the passenger compartment.

C.83. REGULAR SERVICE ENTRANCE

- C.83.1.** On power lift-equipped vehicles, steps shall be the full width of the step well, excluding the thickness of the doors in the open position.
- C.83.2.** In addition to the handrail required in the BUS BODY AND CHASSIS section, an additional handrail shall be provided on all lift buses. This handrail shall be located on the opposite side of the entrance door from the handrail required in the BUS BODY AND CHASSIS section and shall meet the same requirements for handrails.

C.84. RESTRAINING DEVICES

- C.84.1.** On power lift-equipped school buses with a GVWR of 10,000 pounds or more, seat frames may be equipped with attachment points to which belt assemblies can be attached for use with child safety restraint systems (CSRs) that comply with FMVSS No. 213, *Child Restraint Systems*. Any belt assembly anchorage shall comply with FMVSS No. 210, *Seat Belt Assembly Anchorages*.
- C.84.2.** Alternatively, a child restraint anchorage system that complies with FMVSS No. 225, *Child Restraint Anchorage Systems*, may be installed.
- C.84.3.** Seat belt assemblies, if installed, shall conform to FMVSS No. 209, *Seat Belt Assemblies*.
- C.84.4.** Child safety restraint systems, which are used to facilitate the transportation of children who in other modes of transportation would be required to use a child, infant or booster seat, shall conform to FMVSS No. 213.

C.85. SEATING ARRANGEMENTS

- C.85.1.** Flexibility in seat spacing to accommodate special devices shall be permitted to meet passenger requirements. All seating shall meet the requirements of FMVSS No. 222, *School Bus Passenger Seating and Crash Protection*.

C.86. SECUREMENT AND RESTRAINT SYSTEM FOR WHEELCHAIRS AND WHEELCHAIR-SEATED OCCUPANTS

- C.86.1.** For purposes of understanding the various aspects and components of this section, the terms *securement* and *tie down* and the phrases *securement system* or *tie down system* are used exclusively in reference to the devices that anchor the wheelchair to the vehicle. The term *restraint* and the phrase *restraint system* are used exclusively in reference to the equipment that is intended to limit the movement of the wheelchair occupant in a crash or sudden maneuver. The term *wheelchair tie down and occupant restraint system (WTORS)* is used to refer to the total system that secures the wheelchair and restrains the wheelchair occupant.
- C.86.2.** A. WTORS—general requirements:
 - C.86.2.1.** A wheelchair tie down and occupant restraint system installed in specially equipped school buses shall be designed, installed, and operated for use with forward-facing wheelchair-seated passengers and shall comply with all applicable requirements of FMVSS 222, *School Bus Passenger Seating and Crash Protection*, and SAE J2249, *Wheelchair Tie down and Occupant Restraint Systems for Use in Motor Vehicles.1*
 - C.86.2.2.** The WTORS, including the anchorage track, floor plates, pockets or other anchorages, shall be provided by the same manufacturer or shall be certified to be compatible by manufacturers of all equipment/systems used.

- C.86.2.3.** Wheelchair securement positions shall be located such that wheelchairs and their occupants do not block access to the lift door.
- C.86.2.4.** A device for storage of the WTORS shall be provided. When the system is not in use, the storage device shall allow for clean storage of the system, shall keep the system securely contained within the passenger compartment, shall provide reasonable protection from vandalism, and shall enable the system to be readily accessed for use.
- C.86.2.5.** The WTORS, including the storage device, shall meet the flammability standards established in FMVSS No. 302, *Flammability of Interior Materials*.
- C.86.2.6.** The following information shall be provided with each vehicle equipped with a securement and restraint system:
 - C.86.2.6.1. A phone number where information can be obtained about installation, repair and parts. (Detailed written instructions and a parts list shall be available upon request.)
 - C.86.2.6.2. Detailed instructions regarding use, including a diagram showing the proper placement of the wheelchair/mobility aids and positioning of securement devices and occupant restraints, including correct belt angles.
- C.86.2.7.** The WTORS manufacturer shall make training materials available to ensure the proper use and maintenance of the WTORS. These may include instructional videos, classroom curriculum, system test results or other related materials.
- C.86.3.** Wheelchair Securement/Tiedown: (See 49 CFR 571.222, S5.4.1, S5.4.2.) Each wheelchair position in a specially equipped school bus shall have a minimum clear floor area of 30 inches laterally by 48 inches longitudinally. Additional floor area may be required for some wheelchairs. Consultation between the user and the manufacturer is recommended to ensure that adequate area is provided.
- C.86.4.** Occupant restraint system: (See 49 CFR 571.222, S5.4.3, S5.4.4.)

C.87. SPECIAL LIGHT

- C.87.1.** Doorways in which lifts are installed shall be equipped with a special light that provides a minimum of two foot-candles of illumination measured on the floor of the bus immediately adjacent to the lift during lift operation.

C.88. SPECIAL SERVICE ENTRANCE

- C.88.1.** Power lift-equipped bodies shall have a special service entrance to accommodate the power lift. Exception: A special service entrance shall not be required if the lift is designed to operate within the regular service entrance, is capable of stowing such that the regular service entrance is not blocked in any way and a person entering or exiting the bus is not impeded in any way.
- C.88.2.** The special service entrance and door shall be located on the right side of the bus and shall be designed so as not to obstruct the regular service entrance. Exception: A special service entrance and door may be located on the left side of the bus only if the bus is used only to deliver students to the left side of one-way streets and its use is limited to that function.
- C.88.3.** The opening may extend below the floor through the bottom of the body skirt. If such an opening is used, reinforcements shall be installed at the front and rear of the floor opening to support the floor and give the same strength as other floor openings.
- C.88.4.** A drip molding shall be installed above the special service entrance to effectively divert water from the entrance.
- C.88.5.** Door posts and headers at the special service entrance shall be reinforced sufficiently to provide support and strength equivalent to the areas of the side of the bus not used for the special service entrance.

C.89. SPECIAL SERVICE ENTRANCE DOORS

- C.89.1.** A single door or double doors may be used for the special service entrance.
- C.89.2.** A single door shall be hinged to the forward side of the entrance unless this would obstruct the regular service entrance. If the door is hinged to the rearward side of the doorway, the door shall utilize a safety mechanism that will prevent the door from swinging open should the primary door latch fail. If double doors are used, the system shall be designed to prevent the door(s) from

being blown open by the aerodynamic forces created by the forward motion of the bus and shall incorporate a safety mechanism to provide secondary protection should the primary latching mechanism(s) fail.

- C.89.3. All doors shall have positive fastening devices to hold doors in the "open" position when the special service entrance is in use.
- C.89.4. All doors shall be weather sealed.
- C.89.5. When manually operated dual doors are provided, the rear door shall have at least a one-point fastening device to the header. The forward-mounted door shall have at least three one-point fastening devices. One shall be to the header, one to the floor line of the body, and the other shall be into the rear door. The door and hinge mechanism shall have strength that is greater than, or equivalent to, the strength of the emergency exit door.
- C.89.6. Door materials, panels and structural components shall have strength equivalent to the conventional service and emergency doors. Color, rub rail extensions, lettering, and other exterior features shall match adjacent sections of the body.
- C.89.7. Each door shall have windows set in a waterproof manner that are visually similar in size and location to adjacent non-door windows. Glazing shall be of the same type and tinting (if applicable) as standard fixed glass in other body locations.
- C.89.8. Door(s) shall be equipped with a device that will actuate an audible or visible signal located in the driver's compartment when the door(s) is not securely closed and the ignition is in the "on" position.
- C.89.9. A switch shall be installed so that the lift mechanism will not operate when the lift platform door(s) is closed.
- C.89.10. Special service entrance doors shall be equipped with padding at the top edge of the door opening. The padding shall be at least three inches wide and one inch thick and shall extend the full width of the door opening.

C.90. SUPPORT EQUIPMENT AND ACCESSORIES

- C.90.1. In addition to the webbing cutter required in the BUS BODY AND CHASSIS section, each specially equipped school bus that is set up to accommodate wheelchairs or other assistive or restraint devices with webbing attached shall contain an additional webbing cutter properly secured in a location to be determined by the purchaser. The webbing cutter shall meet the requirements listed in the BUS BODY AND CHASSIS section, seats and Restraining Barriers, Section C.49.5.
- C.90.2. Special equipment or supplies that are used in the bus for mobility assistance, health Support, or safety purposes shall meet local, federal and engineering standards that may apply, including requirements for proper identification. Equipment that may be used for these purposes includes, but is not limited to:
 - C.90.2.1. Wheelchairs and other mobile seating devices. (See subsection on Securement and Restraint System for Wheelchairs and Wheelchair-seated Occupants.)
 - C.90.2.2. Crutches, walkers, canes and other ambulating devices to assist ambulation.
 - C.90.2.3. Medical support equipment. This may include respiratory devices, such as oxygen bottles (which should be no larger than 38 cubic feet for compressed gas) or ventilators. Tanks and valves should be located and positioned to protect them from direct sunlight, bus heater vents, or other heat sources. Other equipment may include intravenous and fluid drainage apparatus.

C.91. SUSPENSION

- C.91.1. Type C/D special needs buses that are equipped with a wheelchair lift shall have an air-ride rear suspension system.

C.92. TECHNOLOGY AND EQUIPMENT, NEW

- C.92.1. These specifications are intended to accommodate new technologies and equipment that will better facilitate the transportation of students with special needs. New technology and equipment is acceptable for use in specially equipped vehicles if:

- C.92.1.1. It does not compromise the effectiveness or integrity of any major safety system. Examples of safety systems include, but are not limited to, compartmentalization, the eight-lamp warning system, emergency exits and the approved color scheme.)
- C.92.1.2. It does not diminish the safety of the bus interior.
- C.92.1.3. It does not create additional risk to students who are boarding or exiting the bus or are in or near the school bus loading zone.
- C.92.1.4. It does not require undue additional activity and/or responsibility for the driver.
- C.92.1.5. It generally increases efficiency and/or safety of the bus, generally provides for a safer or more pleasant experience for the occupants and pedestrians in the vicinity of the bus, and generally assists the driver and makes his/her many tasks easier to perform.

D. EVALUATION

D.1. Evaluation Criteria

- D.1.1. This RFP will be evaluated on the following criteria: Cost, Compliance with Specifications, and References

E. INSTRUCTIONS TO SUPPLIER

None

F. CHECKLIST

None

G. OTHER

APPENDIX for Oklahoma Minimum School Bus Specifications 2012 SCHOOL BUS BODY AND CHASSIS

National School Bus Yellow Standard

The color known as "National School Bus Yellow" (NSBY) is specified and described in the School Bus Manufacturers Technical Council publication SBMTC-008, National School Bus Yellow Color Standard.

Note: Information concerning the purchase of this standard may be obtained from the Executive Director of the National Association of State Directors of Pupil Transportation Services (NASDPTS) at 1-800-585-0340 or execdir@nasdpts.org.

G.1. Bus Body Heating System Test

Scope

This procedure, limited to liquid coolant systems, establishes uniform cold weather bus vehicle heating system test procedures for all vehicles designed to transport ten (10) or more passengers. Required test equipment, facilities and definitions are included. Defrosting and defogging procedures and requirements are established by SAE J381, Windshield Defrosting Systems Test Procedure and Performance Requirements—Trucks, Buses, and Multipurpose Vehicles, and SAE J382, Windshield Defrosting Systems Performance Guidelines—Trucks, Buses, and Multi-Purpose Vehicles, which are hereby included by reference.

G.1.1. Purpose

This procedure is designed to provide bus manufacturers with a cost-effective, standardized test method to provide relative approximations of cold weather interior temperatures.

G.2. Definitions

- G.2.1. **Heat Exchanger System** - Means will exist for providing heating and windshield defrosting and defogging capability in a bus. The system shall consist of an integral assembly or assemblies, having a core assembly or assemblies, blower(s), fan(s) and necessary duct systems and controls to provide heating, defrosting and defogging functions. If the bus body structure makes up some portion of the duct system, this structure or a simulation of this structure must be included as part of the system.
- G.2.2. **Heat Exchanger Core Assembly** - The core shall consist of a liquid-to-air heat transfer surface(s), liquid inlet and discharge tubes or pipes.
- G.2.3. **Heat Exchanger-Defroster Blower** - An air moving device(s) compatible with energies available on the bus body.

- G.2.4. Coolant** - A 50-50 solution of commercially available glycol antifreeze and commercial purity water. Commercial purity water is defined as “that water obtained from a municipal water supply system.”
- G.2.5. Heat Exchanger-Defroster Duct System** - Passages that conduct inlet and discharge air throughout the heater system. The discharge outlet louvers shall be included as part of the system.
- G.2.6. Heater Test Vehicle** - The completed bus as designed by the manufacturer with or without a chassis, engine and driver train, including the defined heat exchanger system. If the vehicle is without a chassis, it shall be placed on the test site in such a way that the finished floor of the body is at a height, from the test site floor, equal to its installed height when on a chassis, and all holes and other openings normally filled when installed on a chassis will be plugged.
- G.2.7. Heat Transfer** - The transfer of heat from liquid to air is directly proportional to the difference between the temperatures of the liquid and air entering the transfer system, for a given rate of liquid and air flow measured in pounds per minute, and that heat removed from liquid is equal to heat given to air.

G.3. Equipment

- G.3.1. Test Site** - A suitable location capable of maintaining an average ambient temperature not to exceed 25°F (-3.9°C) for the duration of the test period. The maximum air velocity across the vehicle shall be 5 mph (8 kph).
- G.3.2. Coolant Supply** - A closed loop system, independent of any engine/drive train system, capable of delivering a 50-50 (by volume) solution of antifreeze-water, as defined in 2.4, at 150°±5° (65.5°±1.7°C) above the test site ambient temperature, and 50 lbs (22.7 kg) per minute flow. The coolant supply device shall be equipped with an outlet diverter valve to circulate coolant within the device during its warm-up period. The valve will then permit switching the coolant supply to the bus heat exchanger system at the start of the test.
- G.3.3. Power Equipment Supply** - A source capable of providing the required test voltage and current for the heater system.
- G.3.4. Heat Exchange Units** - The heat exchangers used shall be labeled as specified by the School Bus Manufacturers Technical Council Standard No. 001, *Procedure for Testing and Rating Automotive Bus Hot Water and Heating and Ventilating Equipment* (Revised 4/94). The test rating of each unit, and quantity used, shall be recorded.

G.4. Instrumentation

- G.4.1. Air Temperature**
 - G.4.1.1. Interior** - Recommended air temperature measuring instrumentation are thermocouples or resistance temperature detectors (RTDs). Thermometers are not recommended because of their slow response to rapid temperature changes. Measuring instrumentation shall be placed on alternate seat rows beginning 39±5 inches (99±13 cm) from the rear of the body, at 36±2 inches (91±5 cm) from the finished floor of the body, and on the longitudinal centerline of the body.
 - G.4.1.2. Ambient** - A set of four electrically averaged temperature measuring devices shall be placed 18±5 inches (46±13 cm) from the nearest body surface, 96±5 inches (243±13 cm) above the floor of test site. One measuring device shall be placed at each of the following locations:
 - G.4.1.2.1. Midline of body forward of windshield;
 - G.4.1.2.2. Midline of body aft of the rear surface; and
 - G.4.1.2.3. Midway between the axles on the right and left sides of the body.
 - G.4.1.3. Driver** - Measuring devices shall be placed at appropriate locations to measure ankle, knee, and breath level temperatures with the driver’s seat in rearmost, lowest and body center-most position.
 - G.4.1.3.1. (1) Ankle Level - Place a minimum of four electrically averaged temperature measuring devices at the corners of a 10 x 10 inches (25x25cm) square area, the rearmost edge of which begins 8 inches (20 cm) forward of the front edge of, and centered on, the seat cushion. The devices shall be located 3±0.5 inches (7.5±1.3 cm) above floor surface.

- G.4.1.3.2. Knee Level - Place a minimum of one measuring device at the height of the front top edge of the seat cushion and on the centerline of the seat. This measurement shall be 4 ± 1 inches (10 ± 2.5 cm) forward of the extreme front edge of the seat cushion and parallel to the floor.
- G.4.1.3.3. Breath Level - Place a minimum of one measuring device 42 ± 2 inches (107 ± 5 cm) above the floor and 10 ± 2 inches (25 ± 5 cm) forward of the seat back. The forward dimension shall be measured from the upper edge of the seat back and parallel to the floor.
- G.4.1.4. (Optional) Heat Exchanger Inlet and Outlet Temperature - A minimum of four electrically averaged temperature measuring devices shall be used to measure the inlet air temperature of each heat exchange unit. Additionally, a minimum of four electronically averaged temperature measuring devices shall be used to measure the outlet air temperature of each heat exchange unit. These sensors shall be placed no closer than 2.0 inches (5.1 cm) from the face of any heater core, to prevent any incidence of radiant heat transfer. Outlet sensors shall be distributed throughout the outlet air stream(s) 1.0 ± 0.25 inches (2.5 ± 0.6 cm) from the outlet aperture(s) of the unit heater.
- G.4.1.5. (Optional) Defrost Air Temperature - The temperature of the defrost air shall be measured at a point in the defroster outlet(s) that is in the main air flow and which is at least 1.0 inch (2.54 cm) below (upstream of) the plane of the defroster outlet opening. At least one temperature measurement shall be made in each outlet unit. The interior surface temperature(s) of the windshield shall be measured at a point located on the vertical and horizontal centerline(s) of the windshield.
- G.4.1.6. (Optional) Entrance Area Temperature - The temperature of the vehicle entrance area shall be measured by two sets of three each electrically averaged temperature measuring devices. One set of three devices shall be placed 1.0 inch (2.54 cm) above the lowest tread of the entrance step, equally spaced on the longitudinal centerline of the tread. The second set of devices shall be placed on the next horizontal surface above the lowest entrance step, 4.0 inches (10.2 cm) from the outboard edge of that surface, spaced identically to the first set of sensors, and placed parallel with the outboard edge of the surface being measured.
- G.4.2. Coolant Temperature - The temperature entering and leaving the heat exchanger/defroster system shall be measured as close to the entrance and exit points of the bus body as possible with an immersion thermocouple or RTD device which can be read within $\pm 0.5^\circ\text{F}$ ($\pm 0.3^\circ\text{C}$).
- G.4.3. Coolant Flow - The quantity of coolant flowing shall be measured by means of a calibrated flow meter or weighing tank to an accuracy of at least 2% of setpoint.
- G.4.4. Coolant Pressure - The coolant differential pressure shall be measured by suitable connection as close as possible to the inlet and outlet of the heat exchanger/defrosting system. Pressure may be read as inlet and outlet pressure and the differential calculated, or read directly as PSID. Pressure readings shall be made with the use of gauges, manometers or transducers capable of reading within ± 0.1 psi (689.5 Pa), accurate to $\pm 0.5\%$ of full scale.
- G.4.5. Additional Instrumentation - Additional instrumentation required for vehicle heat exchanger system testing is a voltmeter and a shunt-type ammeter to read the voltage and current of the complete system. The ammeter and voltmeter shall be capable of an accuracy of $\pm 1\%$ of the reading.

G.5. Test Procedures - Install the heater test vehicle on the test site. Testing shall be conducted in such a way as to prevent the effects of solar heating. At an outdoor test site, testing shall commence and data shall be recorded during the hours following sunset and prior to sunrise, regardless of cloud cover or facility roof. Instrumentation is required to obtain the following readings:

- G.5.1. Vehicle interior (Section G.4.1.1);
- G.5.2. Inlet coolant temperature, at entrance to the bus body (Section G.4.2);
- G.5.3. Discharge coolant temperature, at exit from the bus body (Section G.4.2);
- G.5.4. Voltage and current at main bus bar connection of driver's control panel;
- G.5.5. Ambient temperature (Section G.4.1.2);
- G.5.6. Rate of coolant flow (Section G.4.3);
- G.5.7. Coolant flow pressure (Section G.4.4);

- G.5.8.** Elapsed time (stop watch);
- G.5.9.** Driver's station temperatures (Section G.4.1.3);
- G.5.10.** (Optional) Heat Exchanger Inlet and Outlet Temperatures (Section G.4.1.4);
- G.5.11.** (Optional) Defrost Air Temperature (Section G.4.1.5); and
- G.5.12.** (Optional) Entrance Area Temperature (Section G.4.1.6)

Soak the test vehicle, with doors open, for the length of time necessary to stabilize the interior temperature for a 30-minute period as recorded by the vehicle interior temperature measuring devices, and the coolant temperature as measured by the inlet and outlet coolant temperature measuring devices, at the test site temperature, $\pm 5^{\circ}\text{F}$ ($\pm 2.5^{\circ}\text{C}$), not to exceed 25°F (-3.9°C). Warm up the coolant device to the test temperature immediately prior to the start of the test. Use the coolant supply outlet diverter valve to prevent heated coolant from entering the bus heating system prior to the start of the test. At this time, set the heater controls and all fan controls at maximum, and close all doors. A maximum of two windows may be left open a total of 1.0 inch (2.5 cm) each. A maximum of two occupants may be in the body during the test period. Record all instrumentation readings at five-minute intervals for a period of 1 hour. Recording time shall begin with the initial introduction of heated coolant from the independent coolant supply. The electrical system shall be operated at a maximum of 115% of nominal system voltage ± 0.2 volts, for example: 13.8 VDC ± 0.2 volts for a 12 volt (DC) system, and the heat exchanger system shall be wired with the normal vehicle wiring. *Optional:* Additional flow rates and/or coolant temperatures may also be used to generate supplementary data. Procedure shall be repeated (see 5. Test Procedure) for each additional flow rate and/or coolant temperature.

G.6. Computations

G.6.1. Chart and Computations - Customary Units - Data shall be recorded on Attachment "A" - Chart 6.1, Temperature data shall be recorded at the actual temperatures occurring at the time of testing. Air temperature data shall then be adjusted to a 0°F base prior to the construction of graphs. This data reduction shall be directly proportional to the difference between the actual ambient temperature, at the time of test, and 0°F (i.e., actual ambient of 18°F shall result in a reduction of all air temperatures by 18°F and actual ambient temperature of -8°F shall result in an increase of all air temperatures by 8°F). Temperature data shall be presented in graph form as well as tabular form. One graph shall be constructed for the body interior air temperatures (4.1.1) wherein the recording intervals shall be the X-axis and the $^{\circ}\text{F}$ the Y-axis. A separate graph shall be constructed for the driver's temperatures (4.1.3) using the same units for the axes. Optional temperature data (4.1.4, 4.1.5, 4.1.6) may be similarly graphed separate from the interior data.

G.6.1.1. Optional Computations BTU/Hr. Coolant

Heat Transfer: $Q_w = C_p W_w (T_{in} - T_{out}) \times 60$ where:

G.6.1.1.1. W_w = Flow of Coolant (lb/min) — *measured to ± 2 percent*

G.6.1.1.2. T_{in} = Temperature of Coolant into System ($^{\circ}\text{F}$) — *measured quantity*

G.6.1.1.3. T_{out} = Temperature of Coolant out of System ($^{\circ}\text{F}$) — *measured quantity*

G.6.1.1.4. Q_w = Heat removed From Coolant (Btu/hr) — *calculated quantity*

G.6.1.1.5. C_p = Specific Heat of Coolant = 0.8515 (BTU/lb/ $^{\circ}\text{F}$) — *given quantity*

G.6.2. Chart and Computations - Metric Units - Data shall be recorded on Attachment "B" - Chart 6.2. Temperature data shall be recorded at the actual temperatures occurring at the time of testing. Air temperature data shall then be adjusted to a -18°C base prior to the construction of graphs. This data reduction shall be directly proportional to the difference between the actual ambient temperature, at the time of test, and -18°C (i.e., actual ambient of -7.8°C shall result in a reduction of all air temperatures by 10.2°C and actual ambient temperature of -22.2°C shall result in an increase of all air temperatures by 4.2°C). Temperature data shall be presented in graph form as well as tabular form. One graph shall be constructed for the body interior air temperatures (4.1.1) wherein the recording intervals shall be the X-axis and $^{\circ}\text{C}$ the Y-axis. A separate graph shall be constructed for the driver's temperatures (4.1.3) using the same units for the axes. Optional temperature data (4.1.4, 4.1.5, 4.1.6) may be similarly graphed separate from the interior data.

G.6.2.1. Optional Computations BTU/Hr – Coolant

Heat Transfer: $Q_w = C_p W_w (T_{in} - T_{out}) \times 60$ where:

- G.6.2.1.1. W_w = Flow of Coolant (kg/min) — *measured to ± 2 percent*
- G.6.2.1.2. T_{in} = Temperature of Coolant into System ($^{\circ}\text{C}$) — *measured quantity*
- G.6.2.1.3. T_{out} = Temperature of Coolant out of System ($^{\circ}\text{C}$) — *measured quantity*
- G.6.2.1.4. Q_w = Heat removed From Coolant (Joules/hr) — *calculated quantity*
- G.6.2.1.5. C_p = Specific Heat of Coolant = 3559 (joule/kg/ $^{\circ}\text{C}$) — *given quantity*

G.7. NOISE TEST PROCEDURE

- G.7.1. The vehicle is located so that no other vehicle or signboard, building, hill or other large reflecting surface is within 15.2 m (50 feet) of the occupant's seating position.
- G.7.2. All vehicle doors, windows and ventilators are closed.
- G.7.3. All power-operated accessories are turned off.
- G.7.4. The driver is in the normal seated driving position and the person conducting the test is the only other person in the vehicle.
- G.7.5. A sound level meter is used that is set at the "A-weighting fast" meter response and meets the requirements of:
 - G.7.5.1. The American National Standards Institute, Standard ANSI S1.4-1971: *Specifications for Sound Level Meters*, for Type 1 Meters or
 - G.7.5.2. The International Electrotechnical Commission (IEC), Publication No. 179 1973): *Precision Sound Level Meters*.
- G.7.6. The microphone is located so that it points vertically upward 6 inches to the right and directly in line with, and on the same plane as, the occupant's ear adjacent to the primary noise source.
- G.7.7. If the motor vehicle's engine radiator fan drive is equipped with a clutch or similar device that automatically either reduces the rotational speed of the fan or completely disengages the fan from its power source in response to reduced engine cooling loads, the vehicle may be parked before testing with its engine running at high idle or any other speed the operator chooses for sufficient time, but not more than 10 minutes, to permit the engine radiator fan to automatically disengage.
- G.7.8. With the vehicle's transmission in neutral gear, the engine is accelerated to:
 - G.7.8.1. Its maximum governed speed, if it is equipped with an engine governor or
 - G.7.8.2. Its speed at its maximum rated horsepower, if it is not equipped with an engine governor and the engine is stabilized at that speed.
- G.7.9. The A-weighted sound level reading on the sound level meter for the stabilized engine speed condition referred to in H.1. or H.2., above, is observed and, if it has not been influenced by extraneous noise sources, is recorded.
- G.7.10. The vehicle's engine speed is returned to idle and the procedures set out in paragraphs H. and I. are repeated until 2 maximum sound levels within 2 dBA of each other are recorded. The 2 maximum sound level readings are then averaged; and
- G.7.11. The average obtained in accordance with paragraph J., with a value of 2 dBA subtracted there from to allow for variations in the test conditions and in the capabilities of meters, is the vehicle's interior sound level at the driver's seating position for the purposes of determining compliance with the requirements of this test procedure.

G.8. RETROREFLECTIVE SHEETING DAYTIME COLOR SPECIFICATION

- G.8.1. The daytime color of the RETROREFLECTIVE sheeting used to enhance school bus safety requires different color tolerances in order to assure optimum safety benefit, as well as to be consistent with the color of the school bus. The color of the RETROREFLECTIVE sheeting shall conform to the table below when samples applied to aluminum test panels are measured as specified in ASTM E1164. For colorimetric measurements, material is illuminated by Standard Illuminant D65 at an angle of 45 degrees with the normal to the surface the observations are made in the direction of the normal (45/0 degree geometry). The inverse (0/45 degree geometry) with the illuminant at the normal to the surface and the observations at 45 degrees with the

normal to the surface may also be used. For materials which are directionally sensitive (e.g., prismatic sheeting), the colorimetric measurements are made using circumferential illumination and viewing and the various measurements are averaged. Calculations shall be done in accordance with ASTM E308 using the CIE 1931 (2 degree) Standard Observer.

Retroreflective Sheeting Daytime Color
 Chromaticity Coordinates of Corner Points
 Determining the Permitted Color Area

	1	2	3	4
Yellow X	0.484	0.513	0.517	0.544
Y	0.455	0.426	0.482	0.455

Luminance Factor (Y%) Minimum 10.0
 Maximum 36.0

G.9. SCHOOL BUS SEAT UPHOLSTERY FIRE BLOCK TEST

G.9.1. Test Chamber

G.9.1.1. Cross Section

The suggested test chamber is the same cross section as the bus body in which seats are used with the rear section on each end. If a bus section is not used, the cross section is to be 91±1 inch in width x 75 inches ±3 inches in height. There shall be a door, which does not provide ventilation, in the center of each end of the test chamber. The doors shall be 38±3 inches in width and 53±3 inches in height and include a latch to keep the doors closed during the test. (See Figure 1.)

G.9.1.2. Length

The length of the test chamber shall allow three rows of seats at the minimum spacing recommended by the installer. (See Figure 1, Detail A.) In order that different types of seats may be tested in the same chamber, a length tolerance of plus 45 inches is allowed.

G.9.1.3. Ventilation

G.9.1.3.1. One ventilation opening shall be in each end of the test chamber and shall be 325 square inches ±25 square inches. The bottom of the opening shall be 30 inches ±3 inches above the chamber floor. Ventilation openings shall be on the same side of the test chamber. (See Figure 1.)

G.9.1.3.2. There shall be no ventilation openings along the length of the test chamber.

G.9.1.3.3. A forced-air ventilation system may not be used.

G.9.1.3.4. Baffles shall be used to prevent wind from blowing directly into the ventilation openings.

G.9.1.3.5. Camera View Area

An opening covered with glass shall be provided at the midpoint of the test chamber length for camera viewing. The opening shall allow the camera to view the seat parallel to the seat width. (See Figure 1.)

G.9.2. Test Sample

G.9.2.1. The sample shall be a fully-assembled seat.

G.9.2.2. Record the weight of all padding and upholstery prior to assembly. Record the weight of the fully-assembled seat.

G.9.3. Ignition Source

A paper grocery bag with dimensions of approximately 7x11x18 inches is used to contain double sheets of newsprint (black print only, approximately 22x28inches). The total combined weight of bag and newspaper shall be seven ounces ± 0.5 ounces.

G.9.4. Test Procedure

G.9.4.1. Install three seats in the test chamber at minimum spacing, per installer recommendation. Seats shall be perpendicular to the dimension indicated as "length" in Figure 1. Install so that seat frames will not fall during the test. Seat width shall be determined so that maximum passenger capacity per row (two seats) for the seat style shall be tested.

G.9.4.2. For each test, position the ignition source in the following positions outlined.

FIGURE 1

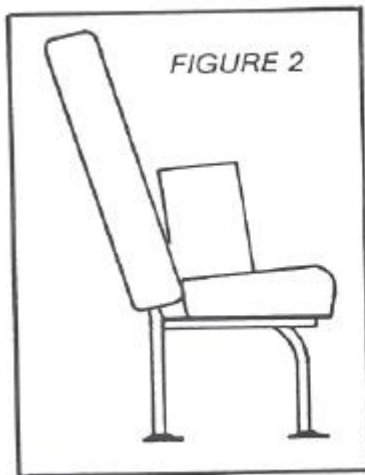
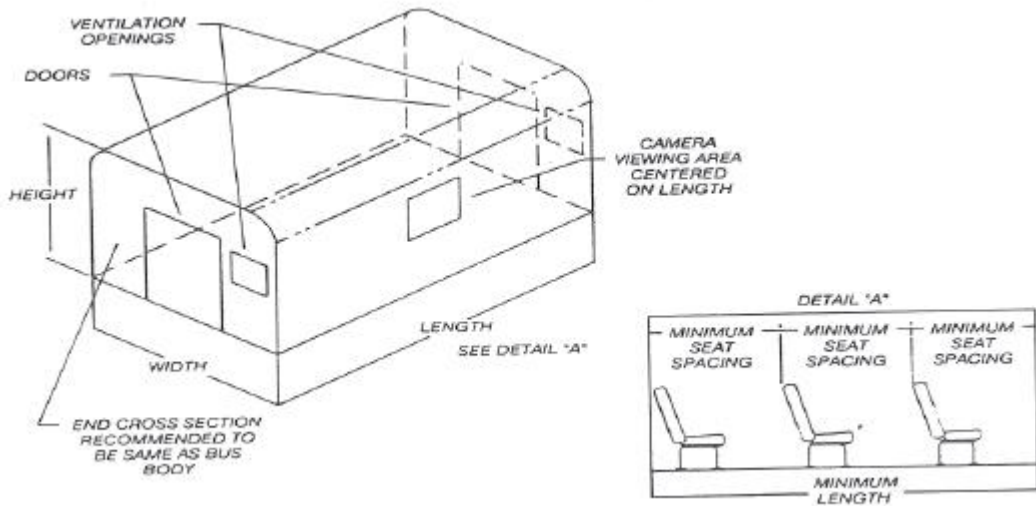

Position A.
Position ignition source with 18-inch dimension in contact with the seat cushion and touching the seat back. Center the bag on top of the cushion. (See Figure 2.)

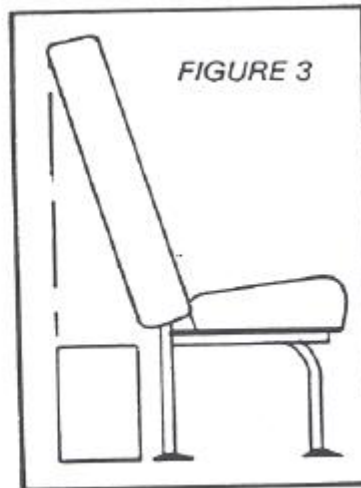

Position B.
Position the ignition source on the floor behind the seat with 18-inch side resting on the floor and parallel to seat width, centered on width so that the rear of bag does not extend beyond the rear seat back. (See Figure 3.)

Position C.
Position the ignition source on the floor on the aisle side of the seat with 18-inch dimension on the floor and perpendicular to the seat width touching the seat leg, with centerline of the bag

at the center of the seat back. (See Figure 4.)

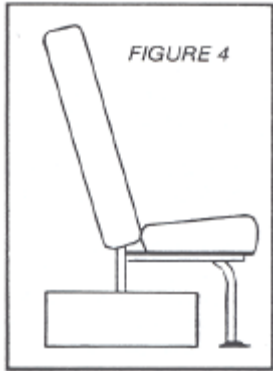

G.9.4.3. A wooden match shall be used to light the ignition source. Time the test, beginning when the ignition source is on fire and ending when all flames are out.

G.9.4.4. After each ignition source position test, weigh seat assembly, including loose material which has fallen off the seat onto the floor.

G.9.5. Performance Criteria

For each ignition source position test, the seat tested must meet all of the following criteria. A new seat specimen may be used for each ignition source position test.

G.9.5.1. 1. Maximum time from ignition to flameout shall be 8 minutes.

G.9.5.2. 2. Flame shall not spread to any other seat with the ignition source in Position A and Position C.

G.9.5.3. 3. Weight loss may not exceed 10% of the pretest weight of padding and upholstery. Padding and upholstery may be combined in the form of integrally bonded seat foam.

Remainder of Page Left Blank Intentionally

Chart 6.1

Description of Unit

Purpose of Test

Date	Location					Observers						
	5	10	15	20	25	30	35	40	45	50	55	60
Readings/Calculations Water												
Flow-lb/min												
Flow Pressure-PSID												
T-in °F												
T-out °F												
Air Temperature												
T1 rear- °F												
T2- °F												
T3- °F												
T4- °F												
T5- °F												
T6-front- °F												
T7-ambient- °F												
T8-Driver Ankle- °F												
T9-Driver Knee- °F												
T10-Driver Breath-°F												
Electrical System												
Volts												
Amps												

COMPUTATIONAL CHART 6.1 (Fahrenheit)

Chart 6.1-Optional Measurements

Readings/Calculations	0	5	10	15	20	25	30	35	40	45	50	55	60
T11-Windshield CL Left- °F													
T12-Windshield CL Right- °F													
T13-Defrost Outlet Left- °F													
T14-Defrost Outlet Right °F													
T15-Heater-Inlet °F													
T15-Heater-Outlet °F													
T16-Heater-Inlet °F													
T16-Heater-Outlet °F													
T17-Heater-Inlet °F													
T17-Heater-Outlet °F													
T18-Heater-Inlet °F													
T18-Heater-Outlet °F													
T19-1st Entrance Step													
T20-2nd Entrance Step													
Heat Transfer-BTU/Hr-coolant													

COMPUTATIONAL CHART 6.1 (Fahrenheit)

Chart 6.2-Optional Measurements

Readings/Calculations	0	5	10	15	20	25	30	35	40	45	50	55	60
T11-Windshield CL Left- °C													
T12-Windshield CL Right- °C													
T13-Defrost Outlet Left- °C													
T14-Defrost Outlet Right °C													
T15-Heater-Inlet °C													
T15-Heater-Outlet °C													
T16-Heater-Inlet °C													
T16-Heater-Outlet °C													
T17-Heater-Inlet °C													
T17-Heater-Outlet °C													
T18-Heater-Inlet °C													
T18-Heater-Outlet °C													
T19-1st Entrance Step													
T20-2nd Entrance Step													
Heat Transfer-J/Hr-coolant													

COMPUTATIONAL CHART 6.2 - Optional (Celsius)

G.11. Attachment "C"

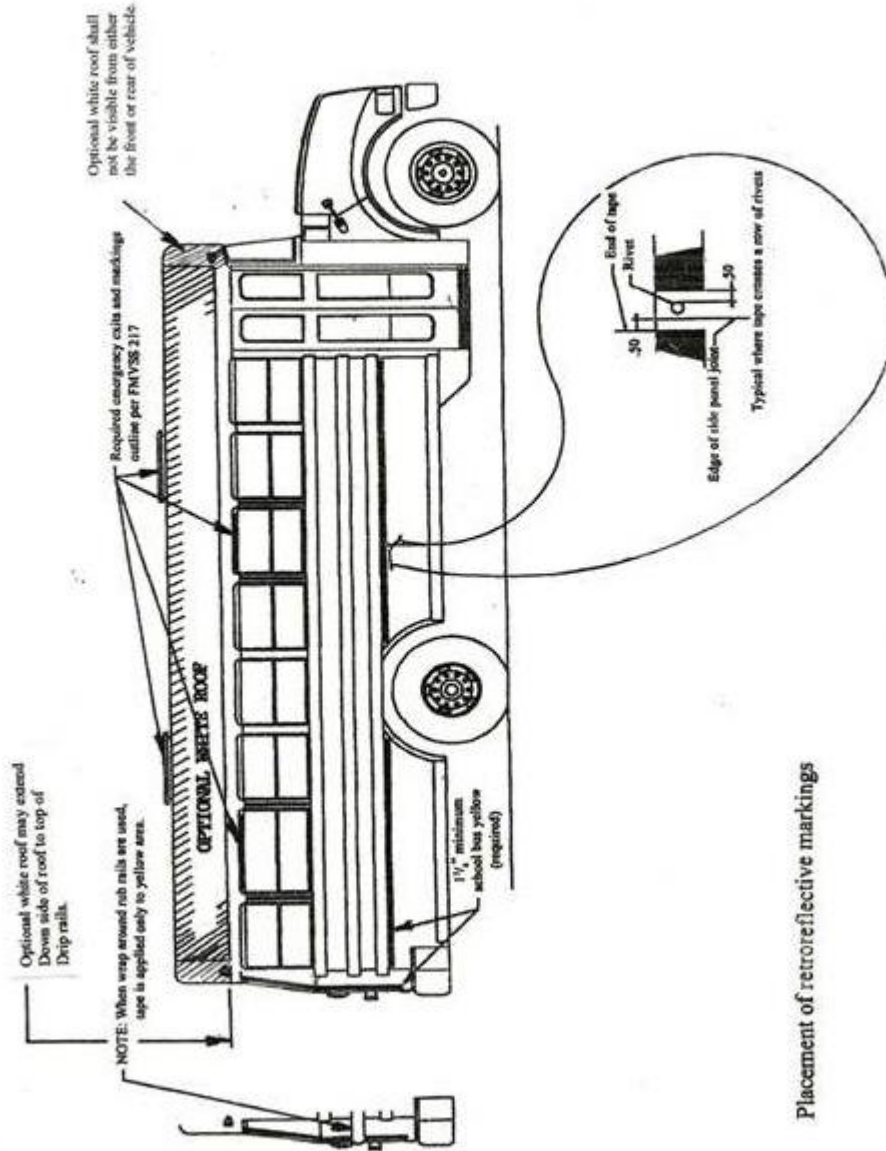

PLACEMENT OF RETROREFLECTIVE MARKINGS AND WHITE ROOF

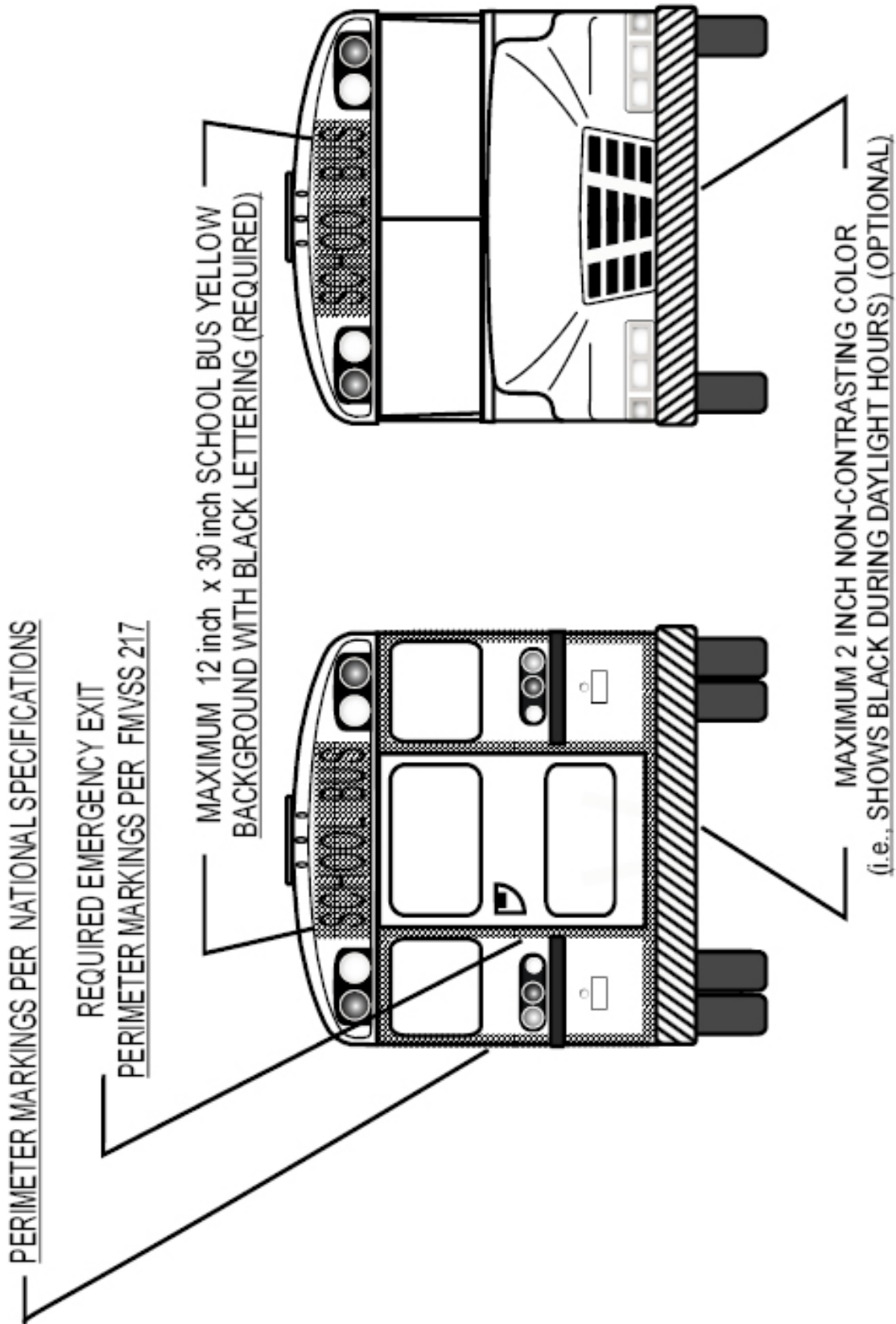

PLACEMENT OF RETROREFLECTIVE MARKINGS

H. PRICE AND COST

H.1. Pricing for Regular Route Buses (Yellow)

- H.1.1. Type C, Up to 39 Passengers \$ _____
- H.1.2. Type C, 40 to 42 Passengers \$ _____
- H.1.3. Type C, 43 to 48 Passengers \$ _____
- H.1.4. Type C, 49 to 54 Passengers \$ _____
- H.1.5. Type C, 55 to 59 Passengers \$ _____
- H.1.6. Type C, 60 to 65 Passengers \$ _____
- H.1.7. Type C, 66 to 71 Passengers \$ _____
- H.1.8. Type C, 72 to 77 Passengers \$ _____

H.2. Pricing for MFSAB Buses

- H.2.1. Type C, 55 to 59 Passengers \$ _____
- H.2.2. Type C, 60 to 65 Passengers \$ _____
- H.2.3. Type C, 66 to 71 Passengers \$ _____
- H.2.4. Type C, 72 to 77 Passengers \$ _____

H.3. Pricing for Specially Equipped Buses

- H.3.1. Type A, Up to 20 Passenger \$ _____
- H.3.2. Type A, 21 to 28 Passenger \$ _____
- H.3.3. Type A, 29 to 36 Passenger \$ _____
- H.3.4. Type B, Up to 30 Passenger \$ _____
- H.3.5. Type B, 31 to 36 Passenger \$ _____
- H.3.6. Type C, Up to 39 Passengers \$ _____
- H.3.7. Type C, 40 to 42 Passengers \$ _____
- H.3.8. Type C, 43 to 48 Passengers \$ _____
- H.3.9. Type C, 49 to 54 Passengers \$ _____
- H.3.10. Type C, 55 to 59 Passengers \$ _____
- H.3.11. Type C, 60 to 65 Passengers \$ _____
- H.3.12. Type C, 66 to 71 Passengers \$ _____
- H.3.13. Type C, 72 to 77 Passengers \$ _____

H.4. Pricing for Transit Buses

- H.4.1. Type D Route, 70-90 Passenger \$ _____
- H.4.2. Type D. MFSAB, 70-90 Passenger \$ _____

H.5. Pricing for Type "A" Passenger Buses

- H.5.1. Type A, Up to 20 Passenger \$ _____
- H.5.2. Type A, 21 to 28 Passenger \$ _____
- H.5.3. Type A, 29 to 36 Passenger \$ _____

H.6. Pricing for Type “B” Passenger Buses

- H.6.1. Type B, Up to 30 Passenger \$ _____
- H.6.2. Type B, 31 to 36 Passenger \$ _____

H.7. Pricing for Optional Specified Items

- H.7.1. Fire Suppression Systems (Section C.70) \$ _____
- H.7.2. Passenger Compartment Air Conditioning (Section C.71) \$ _____
- H.7.3. Insulation (Section C.72) \$ _____
- H.7.4. Retarder System (Section C.73) \$ _____
- H.7.5. Storage Compartment (Section C.74) \$ _____
- H.7.6. Traction Assisting Devices (Section C.75) \$ _____
- H.7.7. Trash Container and Holding Device (Section C.76) \$ _____

H.8. Pricing for Options Not Listed, Provide % off MSRP & Provide List of Options

H.8.1. Vendors can list the discount by Category and then provide a listing of the options for that Category. Several lines have been provided below to fill in the Categories.

- H.8.1.1. Category: _____ Discount: _____ %
- H.8.1.2. Category: _____ Discount: _____ %
- H.8.1.3. Category: _____ Discount: _____ %
- H.8.1.4. Category: _____ Discount: _____ %
- H.8.1.5. Category: _____ Discount: _____ %
- H.8.1.6. Category: _____ Discount: _____ %

H.9. Pricing for Alternative Fuel Engines

H.9.1. Vendors can provide pricing for Alternative Fuel Engines that are available. Only Engine Configurations that have been certified by all required Agencies can be submitted under this Section. Several lines have been provided to provide Pricing.

- H.9.1.1. Engine Type: _____ Price: \$ _____
- H.9.1.2. Engine Type: _____ Price: \$ _____
- H.9.1.3. Engine Type: _____ Price: \$ _____
- H.9.1.4. Engine Type: _____ Price: \$ _____
- H.9.1.5. Engine Type: _____ Price: \$ _____
- H.9.1.6. Engine Type: _____ Price: \$ _____

NOTE REGARDING PRICING FOR OPTIONS NOT LISTED AND ALTERNATIVE FUEL ENGINES:

If needed, a separate document may be provided if pricing varies dependent upon Passenger Capacity. Vendors may submit separate documents for each Passenger Capacity model if needed.